

74288



CATALOGUE 2011

CATALOGUE
2011



Metal Group S.p.a
Divisione Metal Art
Soggetta a Direzione e Coordinamento di Bosetti Marella s.r.l.
Viale Europa, 1/3/5 Cerea (Vr)
T. +39.0442.83460 - F. +39.0442.80722
E-mail: marketingma@metalart1.it
www.metalart1.it



METAL
ART

Metal Art born 30 years ago in Cerea (VR), the typical area of production of Classic furniture, with the purpose and commitment to create and satisfy all requests, even the most demanding for the furniture construction, offering hardware products such as handles, escutcheons, keys, friezes, decorations and items for restoration products, as well as a wide selection of items for the frame sector. Over the years, the company has grown up, by focusing on quality, innovation and continuous research, providing solutions and innovative products, establishing partnerships with the leading Italian and international brands in the sector.

Thanks to these aspects, Metal Art has become the Specialist in the sector, a real “milestone” for Craftsmen, Industry, Interior Designers, Architects.

With this catalog Metal Art aims to provide a variety of products and solutions: furniture handles and accessories, frames, as well as products for the furniture construction and assembly and restoration products.





SHOWROOM

The store **Metal Art** is located in Cerea (Vr), a large showroom of 900 sq mt., with exhibition spaces dedicated to each type of product, in order to show the full range offered, in a visible and more recognizable exhibition: an area dedicated to materials, handles and accessories for window frames, an area with furniture handles and accessories and finally an area with various hardware tools, power tools, restoration products and specific products for the accidents prevention.

Furthermore, with the help of highly qualified Sales assistant, **Metal Art** becomes a reliable partner for all types of Customers. Inside, a corner completely dedicated to Blum, the renowned international brand for systems and closing accessories, is available to touch the quality and innovation of these products. This is only one of the leading and qualified suppliers in our store.



GENERAL TERMS AND CONDITIONS OF SALES

Premise: All sales of Metal Group products are regulated by the following standard terms of sale. These terms are integral part of the contract and are meant to be accepted by the purchaser, even if they haven't been signed by him. Any clause unilaterally specified by the purchaser shall be deemed non-existent and void.

Orders:

- 1 - Orders will be dispatched when the items are available, even not in full. Any balance of the order will be supplied with following shipping. When an unique delivery is requested or when some items need to be delivered together, please mark it while passing the order.
- 2 - Delivery terms, even if confirmed, are only an estimated forecast and have exclusively indicative value, For this reason, delays in delivery shall not entitle the purchaser to claim any form of reimbursement for damages or interests.
- 3 - Please comply with the quantity of a box marked in the catalogue for each item (see "box"). Fixing material is supplied only if requested by the customer and it is not included in the price of item. For different requests, please note that we will supply the minimum quantity in a box.
- 4 - Orders are only accepted when Metal Group has sent to the customer the relative order confirmation. All orders received must be filled in of all necessary details to identify the product, terms of shipment, term of payment and everything else necessary.
- 5 - We reserve the right to change the characteristics of the products illustrated in the catalogue at any time and without giving advance notice.

Shipment:

- 6 - Goods travel at the risk and peril of the Purchaser, no matter how they are shipped. Usually, except special agreement, freight is paid by the Purchaser.

Price:

- 7 - We reserve the right to change prices at any time and without giving advance notice even if we usually inform our customer about changes, which could be done in the price list.

Payments:

- 8 - The Purchaser shall carry out payments according to the terms and conditions stated on the invoice. Late payments will be charged of interests corresponding to the official rate plus 2 points.

Claims and Returns:

- 9 - Any claims must be sent to our head office by registered letter or by fax within and not later than 8 days from the date of receipt of the merchandise. Claims made after that term or by different methods from those listed above, shall not be taken into consideration. Returns are not accepted unless we have explicitly authorized them. For returned merchandise, not depending on the writer's error, will be charged an additional 10% of the value of material delivered. Merchandise must, in any case, be sent back to us free in port and in perfect conditions. Returns of special articles, not included in our catalogue, and specifically ordered by the Purchaser, shall not be accepted.

Court of jurisdiction:

- 10 - This contract is construed in conformity with the Italian Law. Any controversy shall be referred to the Court of Verona, Italy.

Index



Furniture construction

page 1



Furniture handles

page 75



Frame construction

page 101



Frame handles

page 139

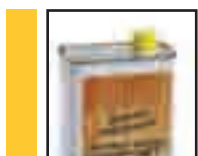

Restoration products

page 151

index

Code	Page	Code	Page	Code	Page	Code	Page
03047.08400.	79	24012.02500.	80	24CF.0245.	93	24EM.014035.	90
03047.11200.	79	24012.03400.	80	24CF.0275.	93	24EM.017030.	90
06013.05700.	79	24017.02500.	81	24CF.0345.	94	24EM.021025.	91
06015.10500.	79	24017.03000.	81	24CF.0375.	94	24EM.021035.	91
09003.03200.	79	24017.03500.	81	24CF.0445.	94	24EM.022055.	91
09003.04100.	79	24018.02000.	81	24CF.0475.	94	24EM.022095.	91
09004.04500.	79	24018.02500.	81	24CF.0545.	94	24EM.023045.	92
09004.06300.	79	24018.03000.	81	24CF.0575.	94	24EM.024040.	92
09004.06700.	79	24018.03500.	81	24CF.0645.	95	24EM.025048.	92
09005.03000.	79	24019.01000.	96	24CF.0675.	95	24EM.026040.	92
09005.04000.	79	24019.01200.	96	24CF.0845.	95	24EM.027040.	92
09012.02800.	79	24019.01500.	96	24CF.0875.	95	24EM.028040.	92
09012.03200.	79	24019.01800.	96	24CF.0945.	95	24EM.029045.	92
09012.04000.	79	24025.02000.	2	24CF.0975.	95	24EM.030045.	92
09012.05000.	79	24025.02500.	2	24EM.001030.	85	24EM.031040.	92
09999.03700.	79	24025.03000.	2	24EM.001040.	85	24EM.032040.	92
12013.04000.	80	24025.03800.	2	24EM.001055.	85	24EM.033048.	92
12013.06500.	80	24026.03000.	2	24EM.002025.	85	24EM.034048.	92
12014.06000.	80	24026.03800.	2	24EM.002035.	85	24EM.036040.	92
15005.08000.	80	24034.01800.	2	24EM.003020.	85-86	24EM.036050.	92
15005.10000.	80	24034.02500.	2	24EM.003025.	85-86	24OR.001035.	80
15005.12000.	80	24034.03000.	2	24EM.003030.	85-86	24TN.001032.	77
15010.21000.	76	24034.03800.	2	24EM.004022.	86	24TN.001043.	77
15023.05000.	76	24035.03000.	2	24EM.005032.	87	24TN.002036.	77
15023.09000.	76	24035.03800.	2	24EM.006030.	87	24TN.002041.	77
15028.07400.	80	24082.06000.	96	24EM.007060.	87-88	26001.24000.	145
15028.08500.	80	24082.08000.	96	24EM.007095.	87-88	26013.15500.	146
15034.21000.	76	24138.02000.	96	24EM.008037.	88	26014.15500.	146
15035.140D0.	76	24138.03000.	96	24EM.008045.	88	26015.09000.	146
15035.140S0.	76	24139.02000.	96	24EM.009037.	88-89	26016.09000.	146
15039.22000.	76	24139.03000.	96	24EM.009045.	88-89	26027.19000.	145
15040.14000.	76	24140.03000.	96	24EM.010045.	89	26031.06400.	146
15042.210D0.	77	24140.04000.	96	24EM.010070.	89	26031.09600.	146
15042.210S0.	77	24141.03000.	96	24EM.011035.	89	26031.12800.	146
15154.19500.	77	24141.04000.	96	24EM.011050.	89	26031.16000.	146
15154.24000.	77	24142.02200.	96	24EM.012030.	90	26032.13200.	146
21002.06500.	80	24142.02500.	96	24EM.012040.	90	26032.16500.	146
21004.05700.	2	24CF.0145.	93	24EM.013050.	90	26032.20000.	146
24012.02000.	80	24CF.0175.	93	24EM.013065.	90	26042.25000.	146

Code	Page	Code	Page	Code	Page	Code	Page
27562.04900.	81	31003.06000.	70	38009.01600.	102	39005.070D0.	29
27562.06500.	81	31004.02500.	98	38010.252D0.	103	39005.070S0.	29
27999.11500.	81	31004.02700.	98	38010.252S0.	103	39005.080D0.	29
30027.04400.	81	31005.04000.	98	38013.430D0.	103	39005.080S0.	29
30028.126V0.	81	31005.04900.	98	38013.430S0.	103	39007.01500.	29
30029.131V0.	81	31006.02100.	98	38017.280D0.	103	39007.02000.	29
30030.048V0.	81	31006.03100.	98	38017.280S0.	103	39007.02500.	29
30031.036V0.	81	31008.04500.	98	38020.210D0.	103	39007.03000.	29
30031.046V0.	81	31008.05500.	98	38020.210S0.	103	39007.03500.	29
30032.126V0.	82	31011.10500.	98	38021.210D0.	104	39007.04000.	29
30033.072V0.	82	31011.13000.	98	38021.210S0.	104	39007.04500.	30
30034.072V0.	82	33005.0480N.	82	38022.300D0.	104	39007.05000.	30
30035.151V0.	82	33015.0380N.	82	38022.300S0.	104	39007.06000.	30
30036.035V0.	82	34001.0450R.	83	38023.180D0.	104	39007.07000.	30
30036.046V0.	82	34002.0540T.	83	38023.180S0.	104	39007.08000.	30
30037.160V0.	82	34003.0460T.	83	38024.180D0.	104	39008.015D0.	30
30038.045V0.	96	34004.0450R.	83	38024.180S0.	104	39008.015S0.	30
30045.054V0.	97	34006.0900R.	83	38025.180D0.	104	39008.020D0.	30
30047.04900.	97	34007.0850R.	83	38025.180S0.	104	39008.020S0.	30
30049.046V0.	97	34008.0520T.	83	38026.200D0.	105	39008.025D0.	30
30055.090V0.	77	34010.0350R.	83	38026.200S0.	105	39008.025S0.	30
30084.03000.	2	36001.05000.	84	38027.18000.	105	39008.030D0.	30
30084.03001.	2	36001.05800.	84	38044.20000.	105	39008.030S0.	30
30084.04000.	2	36002.04600.	84	39005.020D0.	29	39008.035D0.	30
30084.04001.	2	36009.08700.	84	39005.020S0.	29	39008.035S0.	30
30085.03400.	2	36010.08300.	84	39005.025D0.	29	39008.040D0.	30
30086.03400.	2	38003.30000.	102	39005.025S0.	29	39008.040S0.	31
30087.04700.	3	38003.40000.	102	39005.030D0.	29	39008.045D0.	31
30087.05300.	3	38003.50000.	102	39005.030S0.	29	39008.045S0.	31
30088.04000.	3	38004.01000.	102	39005.035D0.	29	39008.050D0.	31
30088.04001.	3	38004.01200.	102	39005.035S0.	29	39008.050S0.	31
30100.060V0.	77	38004.01600.	102	39005.040D0.	29	39008.060D0.	31
30101.040V0.	77	38006.01000.	102	39005.040S0.	29	39008.060S0.	31
30102.075V0.	78	38006.01200.	102	39005.045D0.	29	39008.070D0.	31
30103.090V0.	78	38006.01600.	102	39005.045S0.	29	39008.070S0.	31
31001.04000.	70	38007.30000.	102	39005.050D0.	29	39008.080D0.	31
31002.04000.	70	38007.40000.	102	39005.050S0.	29	39008.080S0.	31
31003.04000.	70	38009.01000.	102	39005.060D0.	29	39008.090D0.	31
31003.05000.	70	38009.01200.	102	39005.060S0.	29	39008.090S0.	31

index

Code	Page	Code	Page	Code	Page	Code	Page
39009.02000.	32	39011.120D0.	33	39015.025D0.	35	39021.03000.	36
39009.02500.	32	39011.120S0.	33	39015.025S0.	35	39023.025D0.	37
39009.03000.	32	39012.025D0.	33	39015.030D0.	35	39023.025S0.	37
39009.03500.	32	39012.025S0.	33	39015.030S0.	35	39023.030D0.	37
39009.04000.	32	39012.030D0.	33	39015.035D0.	35	39023.030S0.	37
39009.05000.	32	39012.030S0.	33	39015.035S0.	35	39023.035D0.	37
39009.06000.	32	39012.035D0.	33	39015.040D0.	35	39023.035S0.	37
39009.07000.	32	39012.035S0.	33	39015.040S0.	35	39023.040D0.	37
39009.08000.	32	39012.040D0.	33	39015.045D0.	35	39023.040S0.	37
39010.01500.	32	39012.040S0.	33	39015.045S0.	35	39023.045D0.	37
39011.025D0.	32	39012.045D0.	33	39015.050D0.	35	39023.045S0.	37
39011.025S0.	32	39012.045S0.	34	39015.050S0.	35	39023.050D0.	37
39011.030D0.	32	39012.050D0.	34	39015.055D0.	35	39023.050S0.	37
39011.030S0.	32	39012.050S0.	34	39015.060D0.	35	39023.055D0.	37
39011.035D0.	32	39012.055D0.	34	39015.060S0.	35	39023.055S0.	37
39011.035S0.	32	39012.060D0.	34	39015.065D0.	35	39023.060D0.	37
39011.040D0.	32	39012.060S0.	34	39015.070D0.	35	39023.060S0.	37
39011.040S0.	32	39012.065D0.	34	39015.070S0.	35	39023.065D0.	37
39011.045D0.	33	39012.070D0.	34	39015.075D0.	35	39023.065S0.	37
39011.045S0.	33	39012.070S0.	34	39015.080D0.	35	39023.070D0.	37
39011.050D0.	33	39012.075D0.	34	39015.080S0.	35	39023.070S0.	37
39011.050S0.	33	39012.080D0.	34	39015.085D0.	35	39023.075D0.	37
39011.055D0.	33	39012.080S0.	34	39015.090D0.	35	39023.075S0.	37
39011.060D0.	33	39012.085D0.	34	39015.090S0.	35	39023.080D0.	37
39011.060S0.	33	39012.090D0.	34	39015.100D0.	36	39023.080S0.	37
39011.065D0.	33	39012.090S0.	34	39015.100S0.	36	39023.085D0.	37
39011.070D0.	33	39012.095D0.	34	39015.110D0.	36	39023.085S0.	37
39011.070S0.	33	39012.100D0.	34	39015.110S0.	36	39023.090D0.	37
39011.075D0.	33	39012.100S0.	34	39015.120D0.	36	39023.090S0.	37
39011.080D0.	33	39012.110D0.	34	39015.120S0.	36	39023.095D0.	37
39011.080S0.	33	39012.110S0.	34	39018.02000.	36	39023.095S0.	37
39011.085D0.	33	39012.120D0.	34	39018.02500.	36	39023.100D0.	37
39011.090D0.	33	39012.120S0.	34	39018.03000.	36	39023.100S0.	37
39011.090S0.	33	39014.015D0.	34	39019.04000.	36	39023.110D0.	38
39011.095D0.	33	39014.015S0.	34	39020.01000.	36	39023.110S0.	38
39011.100D0.	33	39014.02000.	34	39020.01200.	36	39023.120D0.	38
39011.100S0.	33	39014.02500.	34-35	39020.01500.	36	39023.120S0.	38
39011.110D0.	33	39014.030D0.	35	39021.02000.	36	39024.025D0.	38
39011.110S0.	33	39014.030S0.	35	39021.02500.	36	39024.025S0.	38

Code	Page	Code	Page	Code	Page	Code	Page
39024.030D0.	38	39037.02500.	39	39091.03000.	41	40003.67000.	25
39024.030S0.	38	39037.03000.	39	39091.03500.	41	40004.85000.	25
39024.035D0.	38	39038.10000.	39	39091.04000.	41	40005.18000.	3
39024.035S0.	38	39040.01500.	40	39091.04500.	41	40006.21000.	3
39024.040D0.	38	39044.19500.	40	39091.05000.	42	40006.32000.	3
39024.040S0.	38	39073.04800.	40	39091.06000.	42	40008.20500.	3
39024.045D0.	38	39074.10000.	40	39091.07000.	42	40009.17000.	3
39024.045S0.	38	39075.045D0.	40	39091.08000.	42	40010.07000.	3
39024.050D0.	38	39075.045S0.	40	39093.03000.	42	40010.10000.	3
39024.050S0.	38	39075.050D0.	40	39093.04000.	42	40012.25000.	3
39024.060D0.	38	39075.050S0.	40	39093.04500.	42	40013.07000.	4
39024.060S0.	38	39075.060D0.	40	39093.06000.	42	40020.11000.	4
39024.070D0.	38	39075.060S0.	40	39094.05100.	42	40022.11000.	4
39024.070S0.	38	39075.075D0.	40	39095.02500.	42	40023.06500.	4
39024.080D0.	38	39075.075S0.	40	39095.03500.	42	40024.04500.	4
39024.080S0.	38	39076.085D0.	41	39095.04500.	42	40024.07000.	4
39024.090D0.	38	39076.085S0.	41	39096.02900.	42	40024.10000.	4
39024.090S0.	38	39078.04800.	59	39096.03300.	42	40025.14000.	4
39024.100D0.	38	39080.03000.	59	39096.04400.	42	40026.15000.	4
39024.100S0.	38	39082.18000.	46	39096.05200.	42	40027.13000.	4
39024.110D0.	38	39082.24000.	46	39096.06500.	42	40028.08000.	5
39024.110S0.	38	39083.08500.	59	39097.08000.	43	40033.21000.	5
39024.120D0.	38	39084.04000.	59	39097.10000.	43	41003.30000.	70
39024.120S0.	38	39085.03200.	59	39097.12000.	43	41003.36000.	70
39025.025D0.	39	39086.04400.	59	39101.12000.	43	41003.50000.	70
39026.05000.	39	39086.04900.	59	39101.12500.	43	41007Z06400.	60
39026.06500.	39	39087.03300.	59	39102.21600.	46	41007Z08400.	60
39026.08000.	39	39087.03301.	59	39105.10000.	43	41009.09500.	60
39027.01000.	40	39088.02500.	60	39108.09000.	60	41009.15000.	60
39027.01200.	40	39090.02000.	41	39109.04200.	60	41011.12000.	60
39028.08000.	59	39090.02500.	41	39111.10000.	105	41012Z04000.	61
39028.10000.	59	39090.03000.	41	39111.12000.	105	41015.03000.	26
39031.03500.	39	39090.03500.	41	39113.03000.	60	41015.03500.	26
39032.02000.	39	39090.04000.	41	39114.15000.	46	41015.04000.	26
39033.02000.	39	39090.05000.	41	39115.02000.	43	41016.02500.	26
39033.02500.	39	39090.06000.	41	39115.02500.	43	41016.03000.	26
39033.03000.	39	39091.01500.	41	39115.030D0.	43	41016.03500.	26
39037.01500.	39	39091.02000.	41	39115.030S0.	43	41016.04000.	26
39037.02000.	39	39091.02500.	41	40002.75000.	25	41016.05000.	26

index

Code	Page	Code	Page	Code	Page	Code	Page
41017.03000.	26	42019Z03000.	71	45052.10000.	6	45086.10000.	9
41017.03500.	26	42020.07600.	26	45053.05000.	6	45087.03000.	9
41017.04000.	26	42022.01500.	62	45053.06000.	6	45087.04000.	9
41017.05000.	26	42022.02000.	62	45054.03500.	6	45087.05000.	9
41018.00600.	5	42022.02400.	62	45054.04500.	6	45087.06000.	9
41018.00800.	5	42023.01000.	62	45054.09000.	6	45088.07500.	9
41018.01000.	5	42023.02000.	62	45055.11000.	6	45089.09000.	9
41018.01200.	5	42023.02500.	62	45057.10000.	6	45092.09500.	9
41018.01400.	5	42024.08000.	26	45059.11500.	6	45093.07800.	10
41018.01600.	5	42025.07600.	26	45060.10500.	7	45106.08500.	10
41019.04000.	61	42028.01500.	62	45061.12000.	7	45110.13500.	10
41019.06000.	61	43006.04500.	98	45062.08000.	7	45111.10000.	10
41019.08000.	61	43013.03000.	98	45063.15000.	7	45112.12500.	10
41020.02000.	62	43013.04000.	98	45066.04000.	7	45113.10000.	10
41020.03000.	62	43027.06400.	5	45069.03000.	7	45114.06500.	10
41020.04000.	62	43030.08300.	98	45071.07000.	7	45114.08500.	10
41020.05000.	62	44003.02900.	118	45074.07500.	7	45115.15000.	10
41021.04000.	62	44004.03500.	113	45074.09000.	7	45116.12500.	11
41022.02800.	62	44005.22000.	113	45074.11500.	7	45117.15500.	11
41023.13300.	62	44007.24500.	114	45075.21000.	8	45118.10000.	11
41024.14300.	62	44009.03500.	118	45076.09000.	8	45120.10000.	11
41025.14800.	62	44018.02000.	118	45077.11500.	8	45128.03500.	11
41026.03700.	62	44018.02500.	118	45078.07000.	8	45128.05000.	11
41027.00000.	5	44021.00700.	128	45079.06000.	8	45129.20500.	11
41027.01000.	5	44022.00700.	128	45079.08000.	8	45130.09500.	11
41027.02000.	5	44023.00700.	128	45080.13000.	8	45131.08000.	11
42001.02200.	62	44025.02200.	128	45081.13000.	8	45132.04500.	12
42003.C2000.	5	44028.06200.	128	45082.13500.	8	45132.07000.	12
42006.C1200.	27	44092.06000.	119	45083.02000.	9	45132.13000.	12
42006.C2800.	27	44135.01600.	128	45083.03000.	9	45133.11000.	12
42007.C3100.	27	44135.01900.	128	45083.03500.	9	45134.07000.	12
42008.C1200.	70	45017.12000.	5	45083.04000.	9	45134.10000.	12
42009.C1200.	70	45018.08500.	78	45083.05000.	9	45134.13000.	12
42009.C2000.	70	45022.14000.	78	45084.07000.	9	45137.18000.	12
42014Z01500.	70	45040.20000.	5	45084.10000.	9	45140.06000.	12
42015.03000.	26	45040.30000.	5	45085.14000.	9	45140.08000.	12
42016Z01800.	70	45040.75000.	5	45085.25000.	9	45140.10000.	12
42017.03000.	26	45044.03000.	6	45086.05000.	9	45142.05500.	12
42018.05600.	62	45051.14000.	6	45086.06000.	9	45143.04000.	12

Code	Page	Code	Page	Code	Page	Code	Page
45143.05000.	12	46007.07000.	44	48015.03000.	46	48045.07000.	50
45143.06000.	12	46007.10000.	44	48015.03500.	46	48046.08000.	50
45143.07000.	12	46007.20000.	44	48015.04000.	46	48047.15000.	50
45143.08000.	12	46009.09500.	44	48015.05000.	46	48048.07500.	50
45146.10000.	12	47001.08000.	44	48019.03000.	47	48049.075D0.	50
45147.17000.	13	47001.08000.	117	48019.04000.	47	48049.075S0.	50
45159.10500.	13	47002.18000.	117	48019.05000.	47	48049.095D0.	50
45160.13000.	13	47003.15000.	117	48021.01000.	47	48049.095S0.	50
45161.13500.	13	47003.20000.	117	48021.01200.	47	48050.075D0.	50
45164.20000.	13	47003.30000.	117	48021.01400.	47	48050.075S0.	50
45166.10000.	13	47003.40000.	117	48022.04000.	47	48050.095D0.	50
45168.57000.	13	47003.50000.	117	48023.00800.	47	48050.095S0.	50
45169.72500.	13	47004.30000.	117	48023.01000.	47	48051.080D0.	51
45170.03500.	62	47004.40000.	117	48023.01300.	47	48051.080S0.	51
45170.05500.	62	47004.50000.	117	48024.08000.	47	48052.080D0.	51
45171.71000.	14	47004.60000.	117	48026.08200.	47	48052.080S0.	51
45172.58000.	14	47004.80000.	117	48027.18000.	47	48058.080D0.	51
45173.92000.	14	47005.20000.	117	48028.08500.	47	48058.080S0.	51
45206.11000.	14	47005.30000.	117	48029.15000.	48	48058.100D0.	51
45208.06500.	14	47006.50000.	117	48030.14000.	48	48058.100S0.	51
45210.09000.	14	47007.20000.	117	48030.21000.	48	48059.080D0.	51
45211.19000.	14	47007.30000.	117	48031.18200.	48	48059.080S0.	51
45212.12500.	14	47007.40000.	117	48032.15500.	48	48059.100D0.	51
45214.08000.	14	47011.18000.	118	48033.08800.	48	48059.100S0.	51
45220.10500.	15	47012.30000.	118	48034.07200.	48	48063.13500.	51
45221.06500.	15	47012.40000.	118	48035.15000.	48	48064.11000.	51
45222.09500.	15	47012.50000.	118	48036.20500.	48	48065.10500.	52
45223.29500.	15	47029.50000.	118	48037.15000.	49	48065.11500.	52
45224.35500.	15	47032.30000.	118	48038.14000.	49	48069.04000.	52
45225.32500.	15	47032.40000.	118	48039.40000.	49	48070.17500.	52
45254.29001.	78	47033.04800.	118	48040.30000.	49	48070.24000.	52
45BA.001125.	15	48010.10000.	46	48041.39000.	49	48071.05000.	52
45BA.002215.	15	48010.12500.	46	48042.28000.	49	48074.105D0.	52
45BA.006155.	16	48010.15000.	46	48042.33000.	49	48074.105S0.	52
45BA.007200.	16	48011.10000.	46	48042.38500.	49	48075.105D0.	52
45BA.010220.	16	48011.15000.	46	48043.075D0.	49	48075.105S0.	52
46005.07000.	63	48011.20000.	46	48043.075S0.	49	48076.105D0.	52
46006.08000.	43	48014.02500.	46	48044.11000.	49	48076.105S0.	52
46006.09500.	43	48015.02500.	46	48045.05000.	50	48077.105D0.	52

index

Code	Page	Code	Page	Code	Page	Code	Page
48077.105S0.	52	48105.04500.	55	48185Z03500.	58	50008.C190S.	111
48078.085D0.	53	48105.06500.	55	48186Z03500.	58	50011.045D0.	44
48078.085S0.	53	48105.08000.	55	48187.15000.	58	50011.045S0.	44
48078.115D0.	53	48106.10000.	55	49009.250D0.	58	50011.065D0.	44
48078.115S0.	53	48107.12000.	55	49009.250S0.	58	50011.065S0.	44
48079.085D0.	53	48108.12000.	55	49011.02000.	63	50011.095D0.	44
48079.085S0.	53	48109.10000.	55	49011.03500.	63	50011.095S0.	44
48079.115D0.	53	48110.10000.	55	49011.04000.	63	50014.035D0.	112
48079.115S0.	53	48120.10500.	56	49014.05700.	63	50014.035S0.	112
48080.085D0.	53	48121.10500.	56	49015.08600.	63	50014.045D0.	112
48080.085S0.	53	48125.140D0.	56	49016.04700.	63	50014.045S0.	112
48080.115D0.	53	48125.140S0.	56	49018.04500.	63	50014.055D0.	112
48080.115S0.	53	48127.102D0.	56	49019.03500.	63	50014.055S0.	112
48081.12500.	53	48127.102S0.	56	49021.00400.	63	50015.070D0.	112
48081.15500.	53	48127.127D0.	56	49031.02000.	63	50015.070S0.	112
48082.39000.	53	48127.127S0.	56	49031.02600.	63	50017.03500.	112
48083.16000.	54	48129.06500.	56	49037.01700.	64	50019.04000.	113
48083.22000.	54	48130.06500.	56	49044.01600.	71	50019.04500.	113
48093.13500.	54	48143.07000.	56	49044.01800.	71	50019.05000.	113
48094.16700.	54	48144.11000.	56	49044.02000.	71	50020.23800.	113
48096.140D0.	54	48144.20500.	56	49044.02200.	71	50029.11000.	111
48096.140S0.	54	48144.22500.	56	49044.02400.	71	50030.C1600.	111
48096.170D0.	54	48147.10500.	57	49044.02600.	71	50030.C2000.	111
48096.170S0.	54	48151Z07200.	57	49044.02800.	71	50033.C190D.	112
48097.095D0.	54	48153Z10400.	57	49045.02500.	71	50033.C190S.	112
48097.095S0.	54	48155Z08000.	57	49045.03000.	71	50035.12000.	113
48097.120D0.	54	48158.21600.	57	49052.01200.	71	50036.06000.	113
48097.120S0.	54	48160.08000.	43	49085Z05700.	64	50036.06001.	113
48098.01200.	54	48160.10500.	43	49086.40000.	64	50037.06000.	113
48100.03600.	55	48167.06300.	57	49087.20000.	64	52003.C2250.	71
48101.04400.	105	48167.07600.	57	49087.25000.	64	52005.C3000.	71
48101.04800.	105	48167.08900.	57	49087.30000.	64	52006.C3000.	71
48101.05200.	105	48167.10000.	57	49087.35000.	64	52013.60000.	72
48102.05500.	55	48167.12700.	57	49204100001	114	52014.90000.	27
48102.06600.	55	48168.04000.	57	49206000001	114	52015.90000.	27
48103.07800.	55	48168.04300.	57	49206500001	114	52016.90000.	27
48104.09000.	105	48168.05000.	57	49210020001	114	52017.90000.	27
48104.09400.	105	48168.05800.	57	50003.08100.	114	52018.09000.	72
48104.10400.	105	48168.07000.	57	50008.C190D.	111	52022.00000.	72

Code	Page	Code	Page	Code	Page	Code	Page
52028.C3000.	72	53024.75000.	24	53064.12000.	22	55012.00500.	18
52029.00000.	72	53025.75000.	24	53065.09000.	22	55013.00300.	18
53001.08000.	72	53025.75001.	24	53065.12000.	22	55014.00300.	18
53001.10000.	72	53025.75002.	24	53066.09500.	22	55015.01300.	18
53001.12000.	72	53026.44000.	24	53066.11000.	22	55015.01301.	18
53002.12000.	16	53026.75000.	24	53067.13000.	22	55019.01000.	18
53003.13500.	16	53028.75000.	24	53068.08000.	22	55019.01001.	18
53005.04600.	72	53028.75001.	24	53068.12000.	22	55020.01000.	18
53007.08000.	16	53028.75002.	24	53069.16000.	23	55020.01001.	18
53007.10000.	16	53031.75001.	24	53070.16000.	23	55023.00700.	18
53007.12000.	16	53031.75002.	24	53071.16000.	23	55023.00701.	18
53008.08000.	16	53031.75003.	24	53072.18000.	23	55027.00700.	18
53008.10000.	16	53036.05500.	72	53075.43000.	23	55027.00701.	18
53008.12000.	16	53036.07000.	72	53075.74000.	23	55029.00500.	18
53009.06000.	16	53037.10000.	72	53076.43000.	23	55029.00501.	18
53009.08000.	16	53037.12000.	72	53076.74000.	23	55031.01000.	18
53009.10000.	16	53038.05100.	73	53077.43000.	23	55031.01500.	18
53011.06500.	17	53039.08200.	25	53077.74000.	23	55032.01000.	19
53011.07000.	17	53040.10900.	25	53079.43000.	23	55033.00700.	19
53011.08000.	17	53043.22000.	25	53079.74000.	23	55033.01000.	19
53011.09000.	17	53044.40000.	73	53080.43000.	24	55034.00700.	19
53012.05200.	17	53045.45000.	73	53080.74000.	24	55034.01000.	19
53012.07300.	17	53046.40000.	73	55002.00500.	99	55038.00500.	20
53012.08800.	17	53048.07100.	73	55002.00700.	99	55038.00700.	20
53012.10000.	17	53054.71000.	73	55002.01100.	99	55038.00800.	20
53012.12000.	17	53057.07500.	21	55003.00700.	99	55038.01200.	20
53013.10000.	17	53057.09500.	21	55003.00800.	99	55039.01000.	20
53014.06500.	18	53058.12000.	21	55003.01100.	99	55039.01200.	20
53014.08000.	18	53058.16000.	21	55004.00700.	99	55039.01600.	20
53014.09500.	18	53058.21000.	21	55004.00900.	99	55040.01000.	20
53014.12000.	18	53059.06500.	21	55005.03500.	99	55040.01500.	20
53016.05700.	25	53060.08500.	21	55006.03000.	99	55041.02400.	20
53017.04500.	25	53060.09500.	21	55007.03000.	99	55042.02100.	21
53017.05300.	25	53061.08500.	22	55008.01800.	99	55042.03200.	21
53021.42000.	24	53061.10500.	22	55009.00700.	18	55043.03400.	21
53021.75000.	24	53062.12000.	22	55009.01000.	18	55044.01300.	21
53023.42000.	24	53063.12000.	22	55010.00300.	99	55044.02500.	21
53023.75000.	24	53063.16000.	22	55010.00500.	99	55045.01200.	21
53024.42000.	24	53064.09500.	22	55011.01000.	18	55068.00800.	19

index

Code	Page	Code	Page	Code	Page	Code	Page
55072.14000.	19	55118.01800.	28	59006.D1000.	152	61016.01000.	159
55072.18000.	19	55118.02100.	28	59007.C1000.	152	61019.C1000.	156
55073.14000.	19	55118.02900.	28	59007.C5000.	152	61019.D2500.	156
55074.24000.	19	55118.04300.	28	59018.C5000.	152	61021.01000.	157
55075.14000.	19	55119.01800.	28	59036.C1000.	152	61022.C7500.	157
55081.00600.	20	55119.02200.	28	59037.C1000.	152	61022.D5000.	157
55082.01000.	20	55119.02900.	28	59037.D2500.	152	61023.C1000.	157
55087.00900.	20	55119.04300.	28	59037.D5000.	152	61023.C5000.	157
55091.00600.	20	56008.50000.	161	59044.C1000.	153	61024.C1000.	157
55093.12000.	27	56011.C1000.	161	59044.C5000.	153	61024.C5000.	157
55093.12001.	27	56014.C1000.	161	59085.C1000.	153	61032.20000.	157
55113.01800.	27	56015.C1000.	162	59087.C1000.	153	61033.C1000.	157
55113.02200.	27	56032.50000.	162	59089.00000.	153	61034.C1000.	157
55113.02900.	27	56032.C1000.	162	59091.00000.	153	62010.D1000.	158
55113.03400.	27	56033.50000.	162	59092.C1000.	153	62011.00100.	157
55113.04300.	27	56033.C1000.	162	59098.12500.	153	62011.01000.	158
55114.01800.	27	56034.50000.	162	59098.75000.	153	62011.06000.	158
55114.02200.	27	56034.C1000.	162	59099.C1000.	154	62019.06000.	158
55114.02900.	27	56035.50000.	162	59099.C5000.	154	65002.02000.	121
55114.03400.	27	56035.C1000.	162	59099.D1000.	154	65002.02800.	121
55114.04300.	27	56037.50000.	162	59102.50000.	154	65004.01100.	121
55115.01600.	27	56037.C1000.	162	59102.C1000.	154	65004.01600.	121
55115.01800.	27	56039.50000.	162	59102.C5000.	154	65006.03000.	65
55115.02200.	27	56039.C1000.	162	59121.00800.	154	65006.04000.	65
55115.05000.	27	56050.00000.	163	59122.00800.	155	65006.05000.	65
55115.06000.	28	56051.00000.	163	59124.60000.	155	65006.06000.	65
55115.08000.	28	56059.D2500.	163	59125.39000.	155	65006.08000.	65
55115.10000.	28	56059.M2500.	164	59127.C1000.	155	65014.01000.	65
55116.01600.	28	56060.D2500.	163	59131.C1000.	155	65015.01000.	65
55116.01800.	28	56060.M3000.	164	59136.C1000.	152	65015.01200.	65
55116.02200.	28	56061.D2500.	163	61004.02000.	156	65016.01600.	65
55116.06000.	28	56061.M2000.	164	61004.50000.	156	65016.02000.	65
55116.08000.	28	56062.C1000.	162	61010.50000.	156	65017.01600.	65
55116.10000.	28	56064.00000.	164	61013.C5000.	156	65017.02000.	65
55117.01800.	28	56065.00000.	164	61013.D1000.	156	65019.01200.	65
55117.02200.	28	56066.00000.	164	61014.C5000.	156	65019.01500.	65
55117.02900.	28	59006.50000.	152	61014.D1000.	156	65019.02000.	65
55117.03400.	28	59006.C1000.	152	61015.C5000.	156	65019.02500.	65
55117.04300.	28	59006.C2500.	152	61015.D1000.	156	65020.01200.	65

Code	Page	Code	Page	Code	Page	Code	Page
65020.01500.	65-66	65029.08000.	121	65085.02200.	123	65142.08000.	126
65020.01800.	66	65030.02000.	67	65086.03000.	123	65143.08000.	127
65020.02000.	66	65030.03000.	67	65087.04200.	123	65145.03000.	127
65020.02500.	66	65032.01400.	67	65088.01800.	165	65309.01000.	67
65020.03000.	66	65037.02000.	121	65091.01000.	64	65309.01200.	67
65020.03500.	66	65037.02500.	121	65093Z02200.	123	65309.01400.	67
65021.01500.	66	65037.03000.	121	65093Z02700.	123	65309.01600.	67
65021.01800.	66	65037.03500.	121	65093Z03200.	123	65309.01800.	67
65021.02000.	66	65037.04000.	121	65094Z02800.	123	65321.01500.	68
65021.02500.	66	65037.05000.	121	65094Z03600.	123	65321.02000.	68
65021.03000.	66	65037.06000.	121	65095Z03500.	124	65322.01200.	68
65021.03500.	66	65037.07000.	121	65095Z04500.	124	65322.01400.	68
65021.04000.	66	65037.08000.	121	65096.17000.	124	65322.01600.	68
65022.01800.	66	65037.09000.	121	65097.14500.	124	65322.01800.	68
65022.02000.	66	65037.10000.	121	65098.16000.	124	65322.02000.	68
65022.02500.	66	65037.12000.	121	65099.14500.	124	65322.02200.	68
65022.03000.	66	65039.01900.	64	65103.02600.	124	65322.02400.	68
65022.03500.	66	65039.02500.	64	65104.03000.	124	65322.02600.	68
65022.04000.	66	65039.03000.	64	65108.C1000.	165	65322.02800.	68
65022.04500.	66	65049.06000.	69	65111.04000.	124	65322.03000.	68
65022.05000.	66	65057Z01500.	64	65111.06000.	124	65322.03200.	68
65022.06000.	66	65070.02200.	122	65111.08000.	124	65322.03400.	68
65023.04000.	66	65070.07500.	122	65121.07500.	125	65322.03600.	68
65023.05000.	66	65070.07501.	122	65122.08500.	125	65322.03800.	68
65023.06000.	66	65071.C1000.	165	65123.07000.	125	65322.04000.	68
65024.05000.	66	65072.00900.	165	65124.07500.	125	65322.04200.	68
65024.06000.	66	65072.01100.	165	65125.07500.	125	65322.04400.	68
65024.07000.	67	65073.01000.	165	65126.08000.	125	65322.04600.	68
65024.08000.	67	65074.01300.	165	65126.08500.	125	65322.04800.	68
65025.07000.	67	65075.01400.	165	65126.09000.	125	65328.05000.	69
65027.04500.	67	65076.01000.	165	65127.08000.	125	65328.06000.	69
65028.00800.	67	65077.10500.	122	65128.07500.	125	65328.07000.	69
65028.01000.	67	65078.17000.	122	65130.08000.	126	65328.08000.	69
65029.02000.	121	65079.17500.	122	65131.07000.	126	65328.09000.	69
65029.03000.	121	65080.14000.	122	65132.07500.	126	65328.10000.	69
65029.04000.	121	65081.14500.	122	65138.08000.	126	65347.01500.	69
65029.05000.	121	65082.16000.	123	65139.08000.	126	65347.02000.	69
65029.06000.	121	65083.14500.	123	65140.08000.	126	65347.02500.	69
65029.07000.	121	65084.03000.	123	65141.08000.	126	65347.03000.	69

index

Code	Page	Code	Page	Code	Page	Code	Page
65400.05000.	68-69	B9112	160	FE09050	80	FE09104	115
69033.03500.	158	B9201	160	FE09051	81	FE09105	116
69084.50000.	158	B9203	160	FE09052	141	FE091130	127
69102.00000.	158	B9227	160	FE09053	143	FE091131	127
69110.00500.	158	B9229	160	FE09054	147	FE091132	127
69134.00000.	158	FA310601	159	FE09055	147	FE091301	84
6-GR25	159	FA310605	159	FE09056	149	FE091303	128
73007.05000.	158	FA311501	159	FE09058	145	FE091304	128
73025.01900.	159	FA311505	159	FE09060	143	FE091305	128
73026.02500.	159	FA421675	159	FE09061	143	FE091311	84
73027.03000.	159	FE09001	140	FE09068	144	FE091312	84
73028.03800.	159	FE09002	140	FE09071	143	FE091501	141
73029.05000.	159	FE09003	140	FE09073	143	FE09215	107
73037.C2000.	165	FE09003E70	140	FE09074	149	FE09216	107
AT111	152	FE09006	140	FE09075	149	FE09217	107
AT112	152	FE09012	147	FE09075FC	149	FE09236A	106
AT113	152	FE09013	147	FE09076	141	FE09236B	106
AT114	152	FE09014	140	FE09076E70	141	FE09237A	106
AT300	152	FE09018	140	FE09077	141	FE09237B	106
B4101	159	FE09019	141	FE09078	142	FE09238A	106
B4153	159	FE09020	141	FE09080	147	FE09238B	106
B4163	159	FE09024	142	FE09081	147	FE09239A	106
B4167	159	FE09024E70	142	FE09082	81	FE09239B	106
B4190	159	FE09025	142	FE09083	81	FE09240	106
B4301	159	FE09026	142	FE09084	81	FE09241	106
B4353	159	FE09027	141	FE09085	144	FE09242	107
B4363	159	FE09028	143	FE09086	144	FE09243	107
B4367	159	FE09029	140	FE09087	144	FE09244	107
B4501	161	FE09032	142	FE09087E70	144	FE09245	107
B9002	160	FE09035	142	FE09088	144	FE09246	107
B9005	160	FE09039	147	FE09089	145	FE09247	107
B9012	160	FE09040	147	FE09092	144	FE09250DX	107
B9032	160	FE09041	147	FE09093	144	FE09250SX	107
B9033	160	FE09045	142	FE091009DX	115	FE09251DX	107
B9100	160	FE09046	143	FE091009SX	115	FE09251SX	107
B9103	160	FE09047	143	FE09101	115	FE09252DX	107
B9110	160	FE09048	149	FE091015	145	FE09252SX	107
B9111	160	FE09049	149	FE09102	115	FE09260	107

Code	Page
FE09261	107
FE09262	107
FE09263	107
FE09270	106
FE09271	106
FE09301	119
FE09303	119
FE09304	119
FE09306	119
FE09307	119
FE09308	119
FE09309	119
FE09310	119
FE09401	119
FE09402	120
FE09403	120
FE09404	120
FE09405	120
FE09406	120
FE09407	120
FE09408	120
FE09409	120
FE09410	120
FE09413	120
FE09501	148
FE09502	149
FE09503	148
FE09504	148
FE09505	148

Code	Page
FE09506	149
FE09507	148
FE09509	145
FE09510	149
FE09511	145
FE09512	145
FE09513	149
FE09550	115
FE09551	115
FE09703	108
FE09704DX	108
FE09704SX	108
FE09705	108
FE09708DX	108
FE09708SX	108
FE09709	108
FE09709A	108
FE09710	108
FE09711DX	109
FE09711SX	109
FE09712	109
FE09712A	109
FE09715DX	109
FE09715SX	109
FE09716	116
FE09718DX	109
FE09718SX	109
FE09720DX	109
FE09720SX	109

Code	Page
FE09722	106
FE09723	106
FE09724	106
FE09726	116
FE09727	116
FE09730	106
FE09731	106
FE09732	106
FE09733	106
FE09734	106
FE09735	106
FE09736	106
FE09737	106
FE09801	120
FE09802	120
FE09803	120
FE09804	115
FE09805	115
FE09901	114
FE09902	115
FE09903	115
FE09904DX	114
FE09904SX	114
FE09905	115
FE40502DX	110
FE40502SX	110
FE40903DX	110
FE40903SX	110
FE42201	109





Code	Page
FE42202	109
FE42203	109
FE42204	109
FE42902	109
FESI4X20TB/200	67
FESI4X25TB/200	67
FESI4X30TB/200	67
FESI5X20TB/200	67
FESI5X25TB/200	67
FESI5X30TB/200	67
FESI5X35TB/200	67
NON9116120	161
NON9116130	161
NON9116140	161
NON9116150	161
NON9116160	161
NON9343004	161
NON9343006	161
NON9343008	161
NON9343010	161
NON9343012	161
NON9343014	161
NON9343016	161
SVE2011020L	156
SVE201104L	156
SVE2011750M	156

-  Wooden and wooden paste articles
-  Locks
-  Hinges
-  Small hardware
-  Screws
-  Various

Furniture Construction

Wooden and wooden paste articles

Photo	Code	Finish description	Mat.	Measures mm		Description	Box Pcs
				Size	Ø / C to C		
Wooden and wooden paste articles							
	21004.05700.03	Antique brass	Wood	22x57		Pendant	25
	24025.02000.00	Natural color	Beech		20	Knob with pin	50
	24025.02500.00	Natural color	Beech		25	Knob with pin	50
	24025.03000.00	Natural color	Beech		30	Knob with pin	50
	24025.03800.00	Natural color	Beech		38	Knob with pin	50
	24026.03000.00	Natural color	Beech		30	Knob with bush	50
	24026.03800.00	Natural color	Beech		38	Knob with bush	50
	24034.01800.00	Natural color	Beech		18	Knob with pin	50
	24034.02500.00	Natural color	Beech		25	Knob with pin	50
	24034.03000.00	Natural color	Beech		30	Knob with pin	50
	24034.03800.00	Natural color	Beech		38	Knob with pin	50
	24035.03000.00	Natural color	Beech		30	Knob with bush	50
	24035.03800.00	Natural color	Beech		38	Knob with bush	50
	30084.03000.00	Natural color	Beech	30x30	30	Escutcheons	50
	30084.03001.00	Natural color	Walnut	30x30	30	Escutcheons	50
	30084.04000.00	Natural color	Beech	40x40	40	Escutcheons	50
	30084.04001.00	Natural color	Walnut	40x40	40	Escutcheons	50
	30085.03400.00	Natural color	Beech	34x34	34	Escutcheons	50
	30086.03400.00	Natural color	Beech	34x34	34	Escutcheons	50

Photo	Code	Finish description	Mat.	Measures mm		Description	Box Pcs	
				Size	Ø / C to C			
	30087.04700.00	Natural color	Walnut	47x47	47	Escutcheons	50	
	30087.05300.00	Natural color	Walnut	53x53	53	Escutcheons	50	
	30088.04000.00	Natural color	Beech	40x40	40	Escutcheons	50	
	30088.04001.00	Natural color	Walnut	40x40	40	Escutcheons	50	
	40005.18000.00	Natural color	Wood	83x180x100		Wooden decoration	1	
	40006.21000.00	Natural color	Wood	60x210x60		Wooden decoration	1	
	40006.32000.00	Natural color	Wood	90x320x90		Wooden decoration	1	
	40008.20500.00	Natural color	Wood	205x83x35		Wooden decoration	1	
	40009.17000.00	Natural color	Wood	90x170x95		Wooden decoration	2	
	40010.07000.00	Natural color	Wood	70x 70x22		Wooden decoration	2	
	40010.10000.00	Natural color	Wood	100x100x27		Wooden decoration	2	
	40012.25000.00	Natural color	Wood	78x250x65		Wooden decoration	1	

Wooden and wooden paste articles

















Photo	Code	Finish description	Mat.	Measures mm		Description	Box Pcs
				Size	Ø / C to C		
	40013.07000.00	Natural color	Wooden paste	70x45		Wooden paste decoration	25
	40020.11000.00	Natural color	Wood	50x110x39		Wooden decoration	4
	40022.11000.00	Natural color	Wood	75x110x27		Wooden decoration	4
	40023.06500.00	Natural color	Wooden paste	65x30		Wooden paste decoration	25
	40024.04500.00	Natural color	Wooden paste	45x45		Wooden paste decoration	25
	40024.07000.00	Natural color	Wooden paste	70x50		Wooden paste decoration	25
	40024.10000.00	Natural color	Wooden paste	100x50		Wooden paste decoration	25
	40025.14000.00	Natural color	Wooden paste	140x140		Wooden paste decoration	10
	40026.15000.00	Natural color	Wooden paste	150x130		Wooden paste decoration	10
	40027.13000.00	Natural color	Wooden paste	130x60		Wooden paste decoration	10

Photo	Code	Finish description	Mat.	Measures mm		Description	Box Pcs
				Size	Ø / C to C		
	40028.08000.00	Natural color	Wooden paste	80x55		Wooden paste decoration	25
	40033.21000.00C	Natural color	Wooden paste	180x210		Wooden paste decoration	6
	41018.00600.00	Natural color	Wood	6x1000	6	Wooden pin	50
	41018.00800.00	Natural color	Wood	8x1000	8	Wooden pin	50
	41018.01000.00	Natural color	Wood	10x1000	10	Wooden pin	50
	41018.01200.00	Natural color	Wood	12x1000	12	Wooden pin	50
	41018.01400.00	Natural color	Wood	14x1000	14	Wooden pin	50
	41018.01600.00	Natural color	Wood	16x1000	16	Wooden pin	25
	41027.00000.00	Natural color	Wood	45x15	15	Wooden joint	1000
	41027.01000.00	Natural color	Wood	55x20	10	Wooden joint	1000
	41027.02000.00	Natural color	Wood	56x23	20	Wooden joint	1000
	42003.C2000.00	Natural color	Wood	20x11x2000		Shelf support	10
	43027.06400.00	Natural color	Wood	72x65xM8		Hook	24
	45017.12000.00C	Natural color	Wooden paste	120x85		Wooden paste decoration	10
	45040.20000.00	Natural color	Wood	200x60x10		Wooden decoration	2
	45040.30000.00	Natural color	Wood	300x93x13		Wooden decoration	2
	45040.75000.00	Natural color	Wood	750x200x20		Wooden decoration	2

Wooden and wooden paste articles















Photo	Code	Finish description	Mat.	Measures mm		Description	Box Pcs
				Size	Ø / C to C		
	45044.03000.00	Natural color	Wooden paste	30x30	30	Wooden paste decoration	25
	45051.14000.00	Natural color	Wooden paste	140x140	140	Wooden paste decoration	25
	45052.10000.00	Natural color	Wooden paste	100x100	100	Wooden paste decoration	25
	45053.05000.00	Natural color	Wooden paste	50x50	50	Wooden paste decoration	25
	45053.06000.00	Natural color	Wooden paste	60x60	60	Wooden paste decoration	25
	45054.03500.00	Natural color	Wooden paste	35x35		Wooden paste decoration	25
	45054.04500.00	Natural color	Wooden paste	45x45		Wooden paste decoration	25
	45054.09000.00	Natural color	Wooden paste	90x90		Wooden paste decoration	25
	45055.11000.00	Natural color	Wooden paste	110x38		Wooden paste decoration	25
	45057.10000.00	Natural color	Wooden paste	100x65		Wooden paste decoration	25
	45059.11500.00	Natural color	Wooden paste	115x80		Wooden paste decoration	25

Photo	Code	Finish description	Mat.	Measures mm		Description	Box Pcs
				Size	Ø / C to C		
	45060.10500.00	Natural color	Wooden paste	105x50		Wooden paste decoration	25
	45061.12000.00	Natural color	Wooden paste	120x50		Wooden paste decoration	25
	45062.08000.00	Natural color	Wooden paste	80x50		Wooden paste decoration	25
	45063.15000.00	Natural color	Wooden paste	150x150		Wooden paste decoration	10
	45066.04000.00	Natural color	Wooden paste	40x40	40	Wooden paste decoration	25
	45069.03000.00	Natural color	Wooden paste	30x30	30	Wooden paste decoration	25
	45071.07000.00	Natural color	Wooden paste	70x30		Wooden paste decoration	25
	45074.07500.00	Natural color	Wooden paste	75x55		Wooden paste decoration	25
	45074.09000.00	Natural color	Wooden paste	90x55		Wooden paste decoration	25
	45074.11500.00	Natural color	Wooden paste	115x55		Wooden paste decoration	25

Wooden and wooden paste articles

















Photo	Code	Finish description	Mat.	Measures mm		Description	Box Pcs
				Size	Ø / C to C		
	45075.21000.00	Natural color	Wooden paste	210x90		Wooden paste decoration	10
	45076.09000.00	Natural color	Wooden paste	90x60		Wooden paste decoration	25
	45077.11500.00	Natural color	Wooden paste	115x115		Wooden paste decoration	25
	45078.07000.00	Natural color	Wooden paste	70x55		Wooden paste decoration	25
	45079.06000.00	Natural color	Wooden paste	60x30		Wooden paste decoration	25
	45079.08000.00	Natural color	Wooden paste	80x35		Wooden paste decoration	25
	45080.13000.00	Natural color	Wooden paste	130x50		Wooden paste decoration	10
	45081.13000.00	Natural color	Wooden paste	130x100		Wooden paste decoration	10
	45082.13500.00	Natural color	Wooden paste	135x150		Wooden paste decoration	10

Photo	Code	Finish description	Mat.	Measures mm		Description	Box Pcs
				Size	Ø / C to C		
	45083.02000.00	Natural color	Wood	20x6	20	Wooden decoration	25
	45083.03000.00	Natural color	Wood	30x7	30	Wooden decoration	25
	45083.03500.00	Natural color	Wood	35x8	35	Wooden decoration	25
	45083.04000.00	Natural color	Wood	40x11	45	Wooden decoration	25
	45083.05000.00	Natural color	Wood	50x11	50	Wooden decoration	25
	45084.07000.00	Natural color	Wood	70x6	70	Wooden decoration	10
	45084.10000.00	Natural color	Wood	100x7	100	Wooden decoration	10
	45085.14000.00	Natural color	Wood	140x60x7		Wooden decoration	10
	45085.25000.00	Natural color	Wood	250x110x10		Wooden decoration	2
	45086.05000.00	Natural color	Wood	50x30x6		Wooden decoration	10
	45086.06000.00	Natural color	Wood	60x40x6		Wooden decoration	10
	45086.10000.00	Natural color	Wood	100x60x6		Wooden decoration	10
	45087.03000.00	Natural color	Wood	60x60x6		Wooden decoration	25
	45087.04000.00	Natural color	Wood	40x40x6		Wooden decoration	25
	45087.05000.00	Natural color	Wood	50x50x6		Wooden decoration	25
	45087.06000.00	Natural color	Wood	60x60x6		Wooden decoration	25
	45088.07500.00	Natural color	Wood	75x45x9		Wooden decoration	10
	45089.09000.00	Natural color	Wood	90x40x6		Wooden decoration	10
	45092.09500.00	Natural color	Wood	95x40x6		Wooden decoration	10

Wooden and wooden paste articles

























Photo	Code	Finish description	Mat.	Measures mm		Description	Box Pcs
				Size	Ø / C to C		
	45093.07800.00	Natural color	Wood	78x30x6		Wooden decoration	10
	45106.08500.00	Natural color	Wood	85x85x6		Wooden decoration	10
	45110.13500.00	Natural color	Wood	135x100x7		Wooden decoration	10
	45111.10000.00	Natural color	Wood	80x100x13		Wooden decoration	10
	45112.12500.00	Natural color	Wood	125x110x6		Wooden decoration	10
	45113.10000.00	Natural color	Wood	100x7	100	Wooden decoration	10
	45114.06500.00	Natural color	Wood	60x65x6		Wooden decoration	10
	45114.08500.00	Natural color	Wood	75x85x6		Wooden decoration	10
	45115.15000.00	Natural color	Wood	70x150x6		Wooden decoration	10

Photo	Code	Finish description	Mat.	Measures mm		Description	Box Pcs
				Size	Ø / C to C		
	45116.12500.00	Natural color	Wood	35x125x9		Wooden decoration	10
	45117.15500.00	Natural color	Wood	40x155x5		Wooden decoration	10
	45118.10000.00	Natural color	Wood	40x100x9		Wooden decoration	10
	45120.10000.00	Natural color	Wood	100x7	100	Wooden decoration	10
	45128.03500.00C	Natural color	Wooden paste	35x35		Wooden paste decoration	25
	45128.05000.00C	Natural color	Wooden paste	50x50		Wooden paste decoration	25
	45129.20500.00C	Natural color	Wooden paste	205x40		Wooden paste decoration	10
	45130.09500.00C	Natural color	Wooden paste	95x20		Wooden paste decoration	10
	45131.08000.00C	Natural color	Wooden paste	80x30		Wooden paste decoration	10 CP

Wooden and wooden paste articles

Photo	Code	Finish description	Mat.	Measures mm		Description	Box Pcs
				Size	Ø / C to C		
	45132.04500.00	Natural color	Wood	45x45x5		Wooden decoration	10
	45132.07000.00	Natural color	Wood	70x70x5		Wooden decoration	10
	45132.13000.00	Natural color	Wood	130x130x6		Wooden decoration	10
	45133.11000.00	Natural color	Wood	50x110x7		Wooden decoration	25
	45134.07000.00	Natural color	Wood	70x7	70	Wooden decoration	10
	45134.10000.00	Natural color	Wood	100x8	100	Wooden decoration	10
	45134.13000.00	Natural color	Wood	130x9	130	Wooden decoration	10
	45137.18000.00	Natural color	Wood	180x40x10		Wooden decoration	4
	45140.06000.00	Natural color	Wood	60x5	60	Wooden decoration	10
	45140.08000.00	Natural color	Wood	80x7	80	Wooden decoration	10
	45140.10000.00	Natural color	Wood	100x10	100	Wooden decoration	10
	45142.05500.00	Natural color	Wood	55x7	55	Wooden decoration	10
	45143.04000.00	Natural color	Wood	40x5	40	Wooden decoration	10
	45143.05000.00	Natural color	Wood	50x5	50	Wooden decoration	10
	45143.06000.00	Natural color	Wood	60x7	60	Wooden decoration	10
	45143.07000.00	Natural color	Wood	70x8	70	Wooden decoration	10
	45143.08000.00	Natural color	Wood	80x8	80	Wooden decoration	10
	45146.10000.00	Natural color	Wood	100x65x7		Wooden decoration	10 CP

Photo	Code	Finish description	Mat.	Measures mm		Description	Box Pcs
				Size	Ø / C to C		
	45147.17000.00	Natural color	Wood	170x110x10		Wooden decoration	4
	45159.10500.00C	Natural color	Wooden paste	105x30		Wooden paste decoration	10 CP
	45160.13000.00C	Natural color	Wooden paste	130x85		Wooden paste decoration	10
	45161.13500.00C	Natural color	Wooden paste	135x65		Wooden paste decoration	10
	45164.20000.00C	Natural color	Wooden paste	200x190		Wooden paste decoration	6
	45166.10000.00C	Natural color	Wooden paste	100x80		Wooden paste decoration	10
	45168.57000.00C	Natural color	Wooden paste	570x75		Wooden paste decoration	2
	45169.72500.00C	Natural color	Wooden paste	725x65		Wooden paste decoration	2

Wooden and wooden paste articles

















Photo	Code	Finish description	Mat.	Measures mm		Description	Box Pcs
				Size	Ø / C to C		
	45171.71000.00C	Natural color	Wooden paste	710x65		Wooden paste decoration	2
	45172.58000.00C	Natural color	Wooden paste	580x75		Wooden paste decoration	2
	45173.92000.00C	Natural color	Wooden paste	920x145		Wooden paste decoration	1
	45206.11000.00C	Natural color	Wooden paste	110x30		Wooden paste decoration	10
	45208.06500.00C	Natural color	Wooden paste	20x60		Wooden paste decoration	10
	45210.09000.00C	Natural color	Wooden paste	90x75		Wooden paste decoration	10
	45211.19000.00C	Natural color	Wooden paste	190x105		Wooden paste decoration	10
	45212.12500.00C	Natural color	Wooden paste	125x80		Wooden paste decoration	10
	45214.08000.00C	Natural color	Wooden paste	75x80		Wooden paste decoration	10

Photo	Code	Finish description	Mat.	Measures mm		Description	Box Pcs
				Size	Ø / C to C		
	45220.10500.00C	Natural color	Wooden paste	105x45		Wooden paste decoration	10
	45221.06500.00C	Natural color	Wooden paste	65x45		Wooden paste decoration	10
	45222.09500.00C	Natural color	Wooden paste	95x40		Wooden paste decoration	10
	45223.29500.00C	Natural color	Wooden paste	295x45		Wooden paste decoration	10
	45224.35500.00C	Natural color	Wooden paste	355x85		Wooden paste decoration	10
	45225.32500.00C	Natural color	Wooden paste	325x65		Wooden paste decoration	10
	45BA.001125.00C	Natural color	Wooden paste	125x125		Wooden paste decoration	6
	45BA.002215.00C	Natural color	Wooden paste	215x215		Wooden paste decoration	6

Wooden and wooden paste articles

















Photo	Code	Finish description	Mat.	Measures mm		Description	Box Pcs
				Size	Ø / C to C		
	45BA.006155.00C	Natural color	Wooden paste	155x100		Wooden paste decoration	6
	45BA.007200.00C	Natural color	Wooden paste	200x75		Wooden paste decoration	6
	45BA.010220.00C	Natural color	Wooden paste	220x130		Wooden paste decoration	6
	53002.12000.00	Natural color	Wooden paste	120x80		Wooden paste foot	10
	53003.13500.00	Natural color	Wooden paste	135x80		Wooden paste foot	10
	53007.08000.00	Natural color	Alder	80x60		Wooden foot	24
	53007.10000.00	Natural color	Alder	100x70		Wooden foot	24
	53007.12000.00	Natural color	Alder	116x70		Wooden foot	24
	53008.08000.00	Natural color	Alder	80x75		Wooden foot	24
	53008.10000.00	Natural color	Alder	95x75		Wooden foot	24
	53008.12000.00	Natural color	Alder	120x90		Wooden foot	24
	53009.06000.00	Natural color	Alder	64x95		Wooden foot	24
	53009.08000.00	Natural color	Alder	78x115		Wooden foot	24
	53009.10000.00	Natural color	Alder	94x120		Wooden foot	24

Photo	Code	Finish description	Mat.	Measures mm		Description	Box Pcs
				Size	Ø / C to C		
	53011.06500.00	Natural color	Alder	63x93		Wooden foot	24
	53011.07000.00	Natural color	Alder	65x97		Wooden foot	24
	53011.08000.00	Natural color	Alder	77x120		Wooden foot	24
	53011.09000.00	Natural color	Alder	90x120		Wooden foot	24
	53012.05200.00	Natural color	Alder	52x75		Wooden foot	24
	53012.07300.00	Natural color	Alder	70x84		Wooden foot	24
	53012.08800.00	Natural color	Alder	88x100		Wooden foot	24
	53012.10000.00	Natural color	Alder	95x110		Wooden foot	24
	53012.12000.00	Natural color	Alder	120x130		Wooden foot	24
	53013.10000.00	Natural color	Wood	100x80x70		Wooden foot	6
	53014.06500.00	Natural color	Alder	65x80		Wooden foot	24
	53014.08000.00	Natural color	Alder	80x80		Wooden foot	24
	53014.09500.00	Natural color	Alder	95x118		Wooden foot	24
	53014.12000.00	Natural color	Alder	120x120		Wooden foot	24
	55009.00700.00	Natural color	Wood	2,5x7x1000		Wooden inlay (mt)	25
	55009.01000.00	Natural color	Wood	2,5x10x1000		Wooden inlay (mt)	25
	55011.01000.00	Natural color	Wood	2,5x10x1000		Inlay Zebrawood (mt)	25
	55012.00500.00	Natural color	Wood	2,5x5x1000		Wooden inlay Maple/rose (mt)	25
	55013.00300.00	Natural color	Wood	2,5x3x1000		Wooden inlay- Maple (mt)	25

Wooden and wooden paste articles

















Photo	Code	Finish description	Mat.	Measures mm		Description	Box Pcs
				Size	Ø / C to C		
	55014.00300.00	Natural color	Wood	2,5x3x1000		Black wooden inlay (mt)	25
	55015.01300.00	Natural color	Wood	2x13x1000		Wooden inlay (mt)	25
	55015.01301.00	Natural color	Wood	0,6x13x1000		Wooden inlay (mt)	50
	55019.01000.00	Natural color	Wood	2x10x1000		Wooden inlay (mt)	25
	55019.01001.00	Natural color	Wood	0,6x10x1000		Wooden inlay (mt)	50
	55020.01000.00	Natural color	Wood	2x10x1000		Wooden inlay (mt)	25
	55020.01001.00	Natural color	Wood	0,6x10x1000		Wooden inlay (mt)	50
	55023.00700.00	Natural color	Wood	2x7x1000		Wooden inlay (mt)	25
	55023.00701.00	Natural color	Wood	0,6x7x1000		Wooden inlay (mt)	50
	55027.00700.00	Natural color	Wood	2x7x1000		Wooden inlay (mt)	25
	55027.00701.00	Natural color	Wood	0,6x7x1000		Wooden inlay (mt)	50
	55029.00500.00	Natural color	Wood	2x5x1000		Wooden inlay (mt)	25
	55029.00501.00	Natural color	Wood	0,6x5x1000		Wooden inlay (mt)	50
	55031.01000.00	Natural color	Wood	2,5x10x1000		Wooden inlay Maple/walnut (mt)	25
	55031.01500.00	Natural color	Wood	2,5x15x1000		Wooden inlay Maple/walnut (mt)	25

Photo	Code	Finish description	Mat.	Measures mm		Description	Box Pcs
				Size	Ø / C to C		
	55032.01000.00	Natural color	Wood	2,5x10x1000		Inlay Paduka	25
	55033.00700.00	Natural color	Wood	2,5x7x1000		Inlay - Bois de rose	25
	55033.01000.00	Natural color	Wood	2,5x10x1000		Inlay - Bois de rose	25
	55034.00700.00	Natural color	Wood	2,5x7x1000		Inlay Black/rose	25
	55034.01000.00	Natural color	Wood	2,5x10x1000		Inlay Black/rose	25
	55068.00800.00	Natural color	Wood	2,5x8x1000		Mahogany wooden inlay (mt)	25
	55072.14000.00	Natural color	Wood	140x140		Wooden inlay	4
	55072.18000.00	Natural color	Wood	180x180		Wooden inlay	4
	55073.14000.00	Natural color	Wood	140x140		Wooden inlay	4
	55074.24000.00	Natural color	Wood	240x240		Wooden inlay	4
	55075.14000.00	Natural color	Wood	140x140		Wooden inlay	4

Wooden and wooden paste articles

















Photo	Code	Finish description	Mat.	Measures mm		Description	Box Pcs
				Size	Ø / C to C		
	55081.00600.00	Natural color	Wood	2x6x1000		Wooden inlay	25
	55082.01000.00	Natural color	Wood	2x10x1000		Wooden inlay (mt)	25
	55087.00900.00	Natural color	Wood	2x9x1000		Wooden inlay (mt)	25
	55091.00600.00	Natural color	Wood	2x6x1000		Wooden inlay (mt)	25
	55038.00500.00	Natural color	Wood	2,5x5x900		Carved wood frame	20
	55038.00700.00	Natural color	Wood	3,5x7x1000		Carved wood frame	20
	55038.00800.00	Natural color	Wood	4x8x900		Carved wood frame	20
	55038.01200.00	Natural color	Wood	6x12x1000		Carved wood frame	20
	55039.01000.00	Natural color	Wood	5x10x900		Carved wood frame	20
	55039.01200.00	Natural color	Wood	6x12x900		Carved wood frame	20
	55039.01600.00	Natural color	Wood	8x16x900		Carved wood frame	20
	55040.01000.00	Natural color	Wood	9,5x5x1500		Carved wood frame	10
	55040.01500.00	Natural color	Wood	15x7x1500		Carved wood frame	10
	55041.02400.00	Natural color	Wood	24x6x1500		Carved wood frame	10

Photo	Code	Finish description	Mat.	Measures mm		Description	Box Pcs
				Size	Ø / C to C		
	55042.02100.00	Natural color	Wood	21x15,5x1500		Carved wood frame	10
	55042.03200.00	Natural color	Wood	32x22x1500		Carved wood frame	10
	55043.03400.00	Natural color	Wood	34x11x1500		Carved wood frame	10
	55044.01300.00	Natural color	Wood	13x9x1500		Carved wood frame	10
	55044.02500.00	Natural color	Wood	25x12x1500		Carved wood frame	10
	55045.01200.00	Natural color	Wood	12x5,5x1500		Carved wood frame	10
	53057.07500.00	Natural color	Beech	75x40		Wooden foot	10
	53057.09500.00	Natural color	Beech	95x40		Wooden foot	10
	53058.12000.00	Natural color	Beech	h.120		Wooden foot	10
	53058.16000.00	Natural color	Beech	h.160		Wooden foot	10
	53058.21000.00	Natural color	Beech	h.210		Wooden foot	10
	53059.06500.00	Natural color	Beech	65x120		Wooden foot	10
	53060.08500.00	Natural color	Beech	85x100		Wooden foot	10
	53060.09500.00	Natural color	Beech	95x120		Wooden foot	10

Wooden and wooden paste articles

















Photo	Code	Finish description	Mat.	Measures mm		Description	Box Pcs
				Size	Ø / C to C		
	53061.08500.00	Natural color	Beech	85x85		Wooden foot	10
	53061.10500.00	Natural color	Beech	105x85		Wooden foot	10
	53062.12000.00	Natural color	Beech	120x120		Wooden foot	10
	53063.12000.00	Natural color	Beech	105x120		Wooden foot	10
	53063.16000.00	Natural color	Beech	105x160		Wooden foot	10
	53064.09500.00	Natural color	Beech	120x95		Wooden foot	10
	53064.12000.00	Natural color	Beech	120x120		Wooden foot	10
	53065.09000.00	Natural color	Beech	90x70		Wooden foot	10
	53065.12000.00	Natural color	Beech	120x70		Wooden foot	10
	53066.09500.00	Natural color	Beech	45x95		Wooden cap	10
	53066.11000.00	Natural color	Beech	55x110		Wooden cap	10
	53067.13000.00	Natural color	Beech	h.130		Wooden foot	10
	53068.08000.00	Natural color	Beech	90x80		Wooden foot	10
	53068.12000.00	Natural color	Beech	90x120		Wooden foot	10

Photo	Code	Finish description	Mat.	Measures mm		Description	Box Pcs
				Size	Ø / C to C		
	53069.16000.00	Natural color	Beech	h.160		Wooden foot	4
	53070.16000.00	Natural color	Beech	h.160		Wooden foot	4
	53071.16000.00	Natural color	Beech	h.160		Wooden foot	4
	53072.18000.00	Natural color	Beech	95x180		Wooden foot	4
	53075.43000.00	Natural color	Beech	h.430		Wooden leg	4
	53075.74000.00	Natural color	Beech	h.740		Wooden leg	4
	53076.43000.00	Natural color	Beech	h.430		Wooden leg	4
	53076.74000.00	Natural color	Beech	h.740		Wooden leg	4
	53077.43000.00	Natural color	Beech	h.430		Wooden leg	4
	53077.74000.00	Natural color	Beech	h.740		Wooden leg	4
	53079.43000.00	Natural color	Beech	h.430		Wooden leg	4
	53079.74000.00	Natural color	Beech	h.740		Wooden leg	4

Wooden and wooden paste articles

















Photo	Code	Finish description	Mat.	Measures mm		Description	Box Pcs
				Size	Ø / C to C		
	53080.43000.00	Natural color	Beech	h.430		Wooden leg	4
	53080.74000.00	Natural color	Beech	h.740		Wooden leg	4
	53021.42000.00C	Natural color	Walnut	h.420		Wooden leg	4
	53021.75000.00C	Natural color	Walnut	h.750		Wooden leg	4
	53023.42000.00C	Natural color	Walnut	h.420		Wooden leg	4
	53023.75000.00C	Natural color	Walnut	h.750		Wooden leg	4
	53024.42000.00C	Natural color	Walnut	h.420		Wooden leg	4
	53024.75000.00C	Natural color	Walnut	h.750		Wooden leg	4
	53025.75000.00	Natural color	Poplar	70x750		Table leg	4
	53025.75001.00	Natural color	Beech	70x750		Table leg	4
	53025.75002.00	Natural color	Walnut	70x750		Table leg	4
	53026.44000.00C	Natural color	Walnut	h.440		Wooden leg	4
	53026.75000.00C	Natural color	Walnut	h.750		Wooden leg	4
	53028.75000.00	Natural color	Walnut	70x750		Table leg	4
	53028.75001.00	Natural color	Beech	70x750		Table leg	4
	53028.75002.00	Natural color	Cherry	70x750		Table leg	4
	53031.75001.00	Natural color	Walnut	70x750		Table leg	4
	53031.75002.00	Natural color	Beech	70x750		Table leg	4
	53031.75003.00	Natural color	Cherry	70x750		Table leg	4

Photo	Code	Finish description	Mat.	Measures mm		Description	Box Pcs
				Size	Ø / C to C		
	53043.22000.00C	Natural color	Beech	220x95		Wooden pinnacle	4
	53016.05700.00C	Natural color	Beech	57x100		Wooden cap	25
	53017.04500.00C	Natural color	Walnut	45x87		Wooden cap	25
	53017.05300.00C	Natural color	Walnut	53x99		Wooden cap	25
	53039.08200.00C	Natural color	Walnut	27x82		Wooden cap	25
	53040.10900.00C	Natural color	Walnut	35x109		Wooden cap	25
	40002.75000.00C	Natural color	Walnut	33x75		Wooden cap	24
	40003.67000.00C	Natural color	Walnut	35x67		Wooden cap	24
	40004.85000.00C	Natural color	Walnut	40x85		Wooden cap	24

Wooden and wooden paste articles











Photo	Code	Finish description	Mat.	Measures mm		Description	Box Pcs
				Size	Ø / C to C		
	41015.03000.00	Natural color	Wood	6x30	Kg.1	Wooden pin	6
	41015.03500.00	Natural color	Wood	6x35	Kg.1	Wooden pin	6
	41015.04000.00	Natural color	Wood	6x40	Kg.1	Wooden pin	6
	41016.02500.00	Natural color	Wood	8x25	Kg.1	Wooden pin	6
	41016.03000.00	Natural color	Wood	8x30	Kg.1	Wooden pin	6
	41016.03500.00	Natural color	Wood	8x35	Kg.1	Wooden pin	6
	41016.04000.00	Natural color	Wood	8x40	Kg.1	Wooden pin	6
	41016.05000.00	Natural color	Wood	8x50	Kg.1	Wooden pin	6
	41017.03000.00	Natural color	Wood	10x30	Kg.1	Wooden pin	6
	41017.03500.00	Natural color	Wood	10x35	Kg.1	Wooden pin	6
	41017.04000.00	Natural color	Wood	10x40	Kg.1	Wooden pin	6
	41017.05000.00	Natural color	Wood	10x50	Kg.1	Wooden pin	6
	42015.03000.00	Natural color	Beech	30x50		Pole support	50
	42017.03000.00	Natural color	Beech	30x70		Pole support	50
	42020.07600.00	Natural color	Beech	52x76		Pole support	50
	42024.08000.00	Natural color	Beech	85x65		Pole support	50
	42025.07600.00	Natural color	Beech	52x76		Pole support	50

Photo	Code	Finish description	Mat.	Measures mm		Description	Box Pcs
				Size	Ø / C to C		
	42006.C1200.00	Natural color	Toulipiè	28x1200		Pole	20
	42006.C2800.00	Natural color	Toulipiè	28x2800		Pole	10
	42007.C3100.00C	Natural color	Toulipiè	20x20x3100		Pole support	20
	52014.90000.00	Natural color	Beech	900		Wooden extensions (3 elements)	1
	52015.90000.00	Natural color	Beech	900		Wooden extensions (4 elements)	1
	52016.90000.00C	Natural color	Deal	900		Wooden extensions (3 elements)	1
	52017.90000.00C	Natural color	Deal	900		Wooden extensions (4 elements)	1
	55093.12000.00C	Natural color	Walnut	1200x110		Frame	1
	55093.12001.00C	Natural color	Toulipiè	1200x110		Frame	1
	55113.01800.00C	Natural color	Tanganyika	6/10 h18		Edge	300mt
	55113.02200.00C	Natural color	Tanganyika	6/10 h22		Edge	300mt
	55113.02900.00C	Natural color	Tanganyika	6/10 h29		Edge	300mt
	55113.03400.00C	Natural color	Tanganyika	6/10 h34		Edge	300mt
	55113.04300.00C	Natural color	Tanganyika	6/10 h43		Edge	300mt
	55114.01800.00C	Natural color	Tanganyika	6/10 h18		Smooth edge	120mt
	55114.02200.00C	Natural color	Tanganyika	6/10 h22		Smooth edge	120mt
	55114.02900.00C	Natural color	Tanganyika	6/10 h29		Smooth edge	120mt
	55114.03400.00C	Natural color	Tanganyika	6/10 h34		Smooth edge	120mt
	55114.04300.00C	Natural color	Tanganyika	6/10 h43		Smooth edge	120mt
	55115.01600.00C	Natural color	Tanganyika	6/10 h16		Pre-sticked edge	120mt
	55115.01800.00C	Natural color	Tanganyika	6/10 h18		Pre-sticked edge	120mt
	55115.02200.00C	Natural color	Tanganyika	6/10 h22		Pre-sticked edge	120mt
	55115.05000.00C	Natural color	Tanganyika	6/10 h50		Pre-sticked edge	120mt

Wooden and wooden paste articles

Photo	Code	Finish description	Mat.	Measures mm		Description	Box Pcs
				Size	Ø / C to C		
	55115.06000.00C	Natural color	Tanganyika	6/10 h60		Pre-sticked edge	120mt
	55115.08000.00C	Natural color	Tanganyika	6/10 h80		Pre-sticked edge	120mt
	55115.10000.00C	Natural color	Tanganyika	6/10 h100		Pre-sticked edge	120mt
	55116.01600.00C	Natural color	Tanganyika	6/10 h16		Pre-sticked edge - smooth	120mt
	55116.01800.00C	Natural color	Tanganyika	6/10 h18		Pre-sticked edge - smooth	120mt
	55116.02200.00C	Natural color	Tanganyika	6/10 h22		Pre-sticked edge - smooth	120mt
	55116.06000.00C	Natural color	Tanganyika	6/10 h60		Pre-sticked edge - smooth	120mt
	55116.08000.00C	Natural color	Tanganyika	6/10 h80		Pre-sticked edge - smooth	120mt
	55116.10000.00C	Natural color	Tanganyika	6/10 h100		Pre-sticked edge - smooth	120mt
	55117.01800.00C	Natural color	Tanganyika	10/10 h18		Coupled edge - smooth	170mt
	55117.02200.00C	Natural color	Tanganyika	10/10 h22		Coupled edge - smooth	170mt
	55117.02900.00C	Natural color	Tanganyika	10/10 h29		Coupled edge - smooth	170mt
	55117.03400.00C	Natural color	Tanganyika	10/10 h34		Coupled edge - smooth	170mt
	55117.04300.00C	Natural color	Tanganyika	10/10 h43		Coupled edge - smooth	170mt
	55118.01800.00C	Natural color	Durmast	6/10 h18		Supported edge - smooth	300mt
	55118.02100.00C	Natural color	Durmast	6/10 h21		Supported edge - smooth	300mt
	55118.02900.00C	Natural color	Durmast	6/10 h29		Supported edge - smooth	300mt
	55118.04300.00C	Natural color	Durmast	6/10 h43		Supported edge - smooth	300mt
	55119.01800.00C	Natural color	Durmast	10/10 h18		Coupled edge - smooth	170mt
	55119.02200.00C	Natural color	Durmast	10/10 h22		Coupled edge - smooth	170mt
55119.02900.00C	Natural color	Durmast	10/10 h29		Coupled edge - smooth	170mt	
55119.04300.00C	Natural color	Durmast	10/10 h43		Coupled edge - smooth	170mt	



Photo	Code	Finish description	Mat.	Measures mm		Description	Box Pcs
				Size	Ø / C to C		
Locks							
	39005.020D0.21	Raw iron	Iron		20	Mortise lock-with brass square edge- R	12
	39005.020S0.21	Raw iron	Iron		20	Mortise lock-with brass square edge- L	12
	39005.025D0.21	Raw iron	Iron		25	Mortise lock-with brass square edge- R	12
	39005.025S0.21	Raw iron	Iron		25	Mortise lock-with brass square edge- L	12
	39005.030D0.21	Raw iron	Iron		30	Mortise lock-with brass square edge- R	12
	39005.030S0.21	Raw iron	Iron		30	Mortise lock-with brass square edge- L	12
	39005.035D0.21	Raw iron	Iron		35	Mortise lock-with brass square edge- R	12
	39005.035S0.21	Raw iron	Iron		30	Mortise lock-with brass square edge- L	12
	39005.040D0.21	Raw iron	Iron		40	Mortise lock-with brass square edge- R	12
	39005.040S0.21	Raw iron	Iron		40	Mortise lock-with brass square edge- L	12
	39005.045D0.21	Raw iron	Iron		45	Mortise lock-with brass square edge- R	12
	39005.045S0.21	Raw iron	Iron		45	Mortise lock-with brass square edge- L	12
	39005.050D0.21	Raw iron	Iron		50	Mortise lock-with brass square edge- R	12
	39005.050S0.21	Raw iron	Iron		50	Mortise lock-with brass square edge- L	12
	39005.060D0.21	Raw iron	Iron		60	Mortise lock-with brass square edge- R	12
	39005.060S0.21	Raw iron	Iron		60	Mortise lock-with brass square edge- L	12
	39005.070D0.21	Raw iron	Iron		70	Mortise lock-with brass square edge- R	12
	39005.070S0.21	Raw iron	Iron		70	Mortise lock-with brass square edge- L	12
	39005.080D0.21	Raw iron	Iron		80	Mortise lock-with brass square edge- R	12
	39005.080S0.21	Raw iron	Iron		80	Mortise lock-with brass square edge- L	12
	39007.01500.27	Old iron	Iron		15	Lock R-L	12
	39007.01500.21	Raw iron	Iron		15	Lock R-L	12
	39007.02000.27	Old iron	Iron		20	Lock R-L	12
	39007.02000.21	Raw iron	Iron		20	Lock R-L	12
	39007.02500.27	Old iron	Iron		25	Lock R-L	12
	39007.02500.21	Raw iron	Iron		25	Lock R-L	12
	39007.03000.27	Old iron	Iron		30	Lock R-L	12
	39007.03000.21	Raw iron	Iron		30	Lock R-L	12
	39007.03500.27	Old iron	Iron		35	Lock R-L	12
	39007.03500.21	Raw iron	Iron		35	Lock R-L	12
	39007.04000.27	Old iron	Iron		40	Lock R-L	12
	PITCH N Small size key						

Photo	Code	Finish description	Mat.	Measures mm		Description	Box Pcs
				Size	Ø / C to C		
 <p>PITCH N Small size key</p>	39007.04000.21	Raw iron	Iron		40	Lock R-L	12
	39007.04500.27	Old iron	Iron		45	Lock R-L	12
	39007.04500.21	Raw iron	Iron		45	Lock R-L	12
	39007.05000.27	Old iron	Iron		50	Lock R-L	12
	39007.05000.21	Raw iron	Iron		50	Lock R-L	12
	39007.06000.27	Old iron	Iron		60	Lock R-L	12
	39007.06000.21	Raw iron	Iron		60	Lock R-L	12
	39007.07000.27	Old iron	Iron		70	Lock R-L	12
	39007.07000.21	Raw iron	Iron		70	Lock R-L	12
	39007.08000.27	Old iron	Iron		80	Lock R-L	12
39007.08000.21	Raw iron	Iron		80	Lock R-L	12	
 <p>PITCH N Small size key</p>	39008.015D0.27	Old iron	Iron		15	Recessed lock R	12
	39008.015D0.21	Raw iron	Iron		15	Recessed lock R	12
	39008.015S0.27	Old iron	Iron		15	Recessed lock L	12
	39008.015S0.21	Raw iron	Iron		15	Recessed lock L	12
	39008.020D0.27	Old iron	Iron		20	Recessed lock R	12
	39008.020D0.21	Raw iron	Iron		20	Recessed lock R	12
	39008.020S0.27	Old iron	Iron		20	Recessed lock L	12
	39008.020S0.21	Raw iron	Iron		20	Recessed lock L	12
	39008.025D0.27	Old iron	Iron		25	Recessed lock R	12
	39008.025D0.21	Raw iron	Iron		25	Recessed lock R	12
	39008.025S0.27	Old iron	Iron		25	Recessed lock L	12
	39008.025S0.21	Raw iron	Iron		25	Recessed lock L	12
	39008.030D0.27	Old iron	Iron		30	Recessed lock R	12
	39008.030D0.21	Raw iron	Iron		30	Recessed lock R	12
	39008.030S0.27	Old iron	Iron		30	Recessed lock L	12
	39008.030S0.21	Raw iron	Iron		30	Recessed lock L	12
	39008.035D0.27	Old iron	Iron		35	Recessed lock R	12
	39008.035D0.21	Raw iron	Iron		35	Recessed lock R	12
	39008.035S0.27	Old iron	Iron		35	Recessed lock L	12
	39008.035S0.21	Raw iron	Iron		35	Recessed lock L	12
39008.040D0.27	Old iron	Iron		40	Recessed lock R	12	

Photo	Code	Finish description	Mat.	Measures mm		Description	Box Pcs	
				Size	Ø / C to C			
	39008.040D0.21	Raw iron	Iron		40	Recessed lock R	12	
	39008.040S0.27	Old iron	Iron		40	Recessed lock L	12	
	39008.040S0.21	Raw iron	Iron		40	Recessed lock L	12	
	39008.045D0.27	Old iron	Iron		45	Recessed lock R	12	
	39008.045D0.21	Raw iron	Iron		45	Recessed lock R	12	
	39008.045S0.27	Old iron	Iron		45	Recessed lock L	12	
	39008.045S0.21	Raw iron	Iron		45	Recessed lock L	12	
	39008.050D0.27	Old iron	Iron		50	Recessed lock R	12	
	39008.050D0.21	Raw iron	Iron		50	Recessed lock R	12	
	39008.050S0.27	Old iron	Iron		50	Recessed lock L	12	
	39008.050S0.21	Raw iron	Iron		50	Recessed lock L	12	
	39008.060D0.27	Old iron	Iron		60	Recessed lock R	12	
	39008.060D0.21	Raw iron	Iron		60	Recessed lock R	12	
	39008.060S0.27	Old iron	Iron		60	Recessed lock L	12	
	39008.060S0.21	Raw iron	Iron		60	Recessed lock L	12	
	39008.070D0.27	Old iron	Iron		70	Recessed lock R	12	
	39008.070D0.21	Raw iron	Iron		70	Recessed lock R	12	
	39008.070S0.27	Old iron	Iron		70	Recessed lock L	12	
	39008.070S0.21	Raw iron	Iron		70	Recessed lock L	12	
	39008.080D0.27	Old iron	Iron		80	Recessed lock R	12	
	39008.080D0.21	Raw iron	Iron		80	Recessed lock R	12	
	39008.080S0.27	Old iron	Iron		80	Recessed lock L	12	
	39008.080S0.21	Raw iron	Iron		80	Recessed lock L	12	
	39008.090D0.27	Old iron	Iron		90	Recessed lock R	12	
	39008.090D0.21	Raw iron	Iron		90	Recessed lock R	12	
	39008.090S0.27	Old iron	Iron		90	Recessed lock L	12	
	39008.090S0.21	Raw iron	Iron		90	Recessed lock L	12	

PITCH N Small size key

Photo	Code	Finish description	Mat.	Measures mm		Description	Box Pcs
				Size	Ø / C to C		
	39009.02000.05	Burnished	Iron		20	Lock - ambidextrous	12
	39009.02000.27	Old iron	Iron		20	Lock - ambidextrous	12
	39009.02500.05	Burnished	Iron		25	Lock - ambidextrous	12
	39009.02500.27	Old iron	Iron		25	Lock - ambidextrous	12
	39009.03000.05	Burnished	Iron		30	Lock - ambidextrous	12
	39009.03000.27	Old iron	Iron		30	Lock - ambidextrous	12
	39009.03500.05	Burnished	Iron		35	Lock - ambidextrous	12
	39009.03500.27	Old iron	Iron		35	Lock - ambidextrous	12
	39009.04000.05	Burnished	Iron		40	Lock - ambidextrous	12
	39009.04000.27	Old iron	Iron		40	Lock - ambidextrous	12
	39009.05000.05	Burnished	Iron		50	Lock - ambidextrous	12
	39009.05000.27	Old iron	Iron		50	Lock - ambidextrous	12
	39009.06000.05	Burnished	Iron		60	Lock - ambidextrous	12
	39009.06000.27	Old iron	Iron		60	Lock - ambidextrous	12
	39009.07000.05	Burnished	Iron		70	Lock - ambidextrous	12
	39009.07000.27	Old iron	Iron		70	Lock - ambidextrous	12
39009.08000.05	Burnished	Iron		80	Lock - ambidextrous	12	
39009.08000.27	Old iron	Iron		80	Lock - ambidextrous	12	
PITCH N Small size key							
	39010.01500.27	Old iron	Iron		15	Lock - ambidextrous	12
PITCH N Small size key							
	39011.025D0.27	Old iron	Iron		25	Recessed lock R	12
	39011.025S0.27	Old iron	Iron		25	Recessed lock L	12
	39011.030D0.27	Old iron	Iron		30	Recessed lock R	12
	39011.030S0.27	Old iron	Iron		30	Recessed lock L	12
	39011.035D0.27	Old iron	Iron		35	Recessed lock R	12
	39011.035S0.27	Old iron	Iron		35	Recessed lock L	12
	39011.040D0.27	Old iron	Iron		40	Recessed lock R	12
	39011.040S0.27	Old iron	Iron		40	Recessed lock L	12
PITCH N Small size key							



Photo	Code	Finish description	Mat.	Measures mm		Description	Box Pcs
				Size	Ø / C to C		
	39011.045D0.27	Old iron	Iron		45	Recessed lock R	12
	39011.045S0.27	Old iron	Iron		45	Recessed lock L	12
	39011.050D0.27	Old iron	Iron		50	Recessed lock R	12
	39011.050S0.27	Old iron	Iron		50	Recessed lock L	12
	39011.055D0.27	Old iron	Iron		55	Recessed lock R	12
	39011.060D0.27	Old iron	Iron		60	Recessed lock R	12
	39011.060S0.27	Old iron	Iron		60	Recessed lock L	12
	39011.065D0.27	Old iron	Iron		65	Recessed lock R	12
	39011.070D0.27	Old iron	Iron		70	Recessed lock L	12
	39011.070S0.27	Old iron	Iron		70	Recessed lock L	12
	39011.075D0.27	Old iron	Iron		75	Recessed lock R	12
	39011.080D0.27	Old iron	Iron		80	Recessed lock R	12
	39011.080S0.27	Old iron	Iron		80	Recessed lock L	12
	39011.085D0.27	Old iron	Iron		85	Recessed lock R	12
	39011.090D0.27	Old iron	Iron		90	Recessed lock R	12
	39011.090S0.27	Old iron	Iron		90	Recessed lock L	12
	39011.095D0.27	Old iron	Iron		95	Recessed lock R	12
	39011.100D0.27	Old iron	Iron		100	Recessed lock R	12
	39011.100S0.27	Old iron	Iron		100	Recessed lock L	12
		39011.110D0.27	Old iron	Iron		110	Recessed lock R
39011.110S0.27		Old iron	Iron		110	Recessed lock L	12
39011.120D0.27		Old iron	Iron		120	Recessed lock R	12
39011.120S0.27		Old iron	Iron		120	Recessed lock L	12
39012.025D0.27		Old iron	Iron		25	Lock R	12
39012.025S0.27		Old iron	Iron		25	Lock L	12
39012.030D0.27		Old iron	Iron		30	Lock R	12
39012.030S0.27		Old iron	Iron		30	Lock L	12
39012.035D0.27		Old iron	Iron		35	Lock R	12
39012.035S0.27		Old iron	Iron		35	Lock L	12
PITCH N Small size key	39012.040D0.27	Old iron	Iron		40	Lock R	12
	39012.040S0.27	Old iron	Iron		40	Lock L	12
	39012.045D0.27	Old iron	Iron		45	Lock R	12

Photo	Code	Finish description	Mat.	Measures mm		Description	Box Pcs
				Size	Ø / C to C		
	39012.045S0.27	Old iron	Iron		45	Lock L	12
	39012.050D0.27	Old iron	Iron		50	Lock R	12
	39012.050S0.27	Old iron	Iron		50	Lock L	12
	39012.055D0.27	Old iron	Iron		55	Lock R	12
	39012.060D0.27	Old iron	Iron		60	Lock R	12
	39012.060S0.27	Old iron	Iron		60	Lock L	12
	39012.065D0.27	Old iron	Iron		65	Lock R	12
	39012.070D0.27	Old iron	Iron		70	Lock R	12
	39012.070S0.27	Old iron	Iron		70	Lock L	12
	39012.075D0.27	Old iron	Iron		75	Lock R	12
	39012.080D0.27	Old iron	Iron		80	Lock R	12
	39012.080S0.27	Old iron	Iron		80	Lock L	12
	39012.085D0.27	Old iron	Iron		85	Lock R	12
	39012.090D0.27	Old iron	Iron		90	Lock R	12
	39012.090S0.27	Old iron	Iron		90	Lock L	12
	39012.095D0.27	Old iron	Iron		95	Lock R	12
	39012.100D0.27	Old iron	Iron		100	Lock R	12
	39012.100S0.27	Old iron	Iron		100	Lock L	12
	39012.110D0.27	Old iron	Iron		110	Lock R	12
	39012.110S0.27	Old iron	Iron		110	Lock L	12
39012.120D0.27	Old iron	Iron		120	Lock R	12	
39012.120S0.27	Old iron	Iron		120	Lock L	12	
	39014.015D0.03	Antique brass	Iron		15	Lock R	12
	39014.015D0.05	Burnished	Iron		15	Lock R	12
	39014.015D0.27	Old iron	Iron		15	Lock R	12
	39014.015S0.03	Antique brass	Iron		15	Lock L	12
	39014.015S0.05	Burnished	Iron		15	Lock L	12
	39014.015S0.27	Old iron	Iron		15	Lock L	12
	39014.02000.03	Antique brass	Iron		20	Lock R-L	12
	39014.02000.05	Burnished	Iron		20	Lock R-L	12
	39014.02000.27	Old iron	Iron		20	Lock R-L	12
	39014.02500.03	Antique brass	Iron		25	Lock R-L	12

PITCH N Small size key

PITCH N Small size key

Photo	Code	Finish description	Mat.	Measures mm		Description	Box Pcs
				Size	Ø / C to C		
 <p>PITCH N Small size key</p>	39014.02500.05	Burnished	Iron		25	Lock R-L	12
	39014.02500.27	Old iron	Iron		25	Lock R-L	12
	39014.030D0.03	Antique brass	Iron		30	Lock R	12
	39014.030D0.05	Burnished	Iron		30	Lock R	12
	39014.030D0.27	Old iron	Iron		30	Lock R	12
	39014.030S0.03	Antique brass	Iron		30	Lock L	12
	39014.030S0.05	Burnished	Iron		30	Lock L	12
	39014.030S0.27	Old iron	Iron		30	Lock L	12
 <p>PITCH T Large size key</p>	39015.025D0.27	Old iron	Iron		25	Lock R	12
	39015.025S0.27	Old iron	Iron		25	Lock L	12
	39015.030D0.27	Old iron	Iron		30	Lock R	12
	39015.030S0.27	Old iron	Iron		30	Lock L	12
	39015.035D0.27	Old iron	Iron		35	Lock R	12
	39015.035S0.27	Old iron	Iron		35	Lock L	12
	39015.040D0.27	Old iron	Iron		35	Lock R	12
	39015.040S0.27	Old iron	Iron		40	Lock L	12
	39015.045D0.27	Old iron	Iron		45	Lock R	12
	39015.045S0.27	Old iron	Iron		45	Lock L	12
	39015.050D0.27	Old iron	Iron		50	Lock R	12
	39015.050S0.27	Old iron	Iron		50	Lock L	12
	39015.055D0.27	Old iron	Iron		55	Lock R	12
	39015.060D0.27	Old iron	Iron		60	Lock R	12
	39015.060S0.27	Old iron	Iron		60	Lock L	12
	39015.065D0.27	Old iron	Iron		65	Lock R	12
	39015.070D0.27	Old iron	Iron		70	Lock R	12
	39015.070S0.27	Old iron	Iron		70	Lock L	12
	39015.075D0.27	Old iron	Iron		75	Lock R	12
	39015.080D0.27	Old iron	Iron		80	Lock R	12
	39015.080S0.27	Old iron	Iron		80	Lock L	12
	39015.085D0.27	Old iron	Iron		85	Lock R	12
	39015.090D0.27	Old iron	Iron		90	Lock R	12
	39015.090S0.27	Old iron	Iron		90	Lock L	12







Photo	Code	Finish description	Mat.	Measures mm		Description	Box Pcs
				Size	Ø / C to C		
 <p>PITCH T Large size key</p>	39015.100D0.27	Old iron	Iron		100	Lock R	12
	39015.100S0.27	Old iron	Iron		100	Lock L	12
	39015.110D0.27	Old iron	Iron		110	Lock R	12
	39015.110S0.27	Old iron	Iron		110	Lock L	12
	39015.120D0.27	Old iron	Iron		120	Lock R	12
	39015.120S0.27	Old iron	Iron		120	Lock L	12
 <p>PITCH T Large size key</p>	39018.02000.05	Burnished	Iron		20	Lock - ambidextrous	12
	39018.02000.27	Old iron	Iron		20	Lock - ambidextrous	12
	39018.02500.05	Burnished	Iron		25	Lock - ambidextrous	12
	39018.02500.27	Old iron	Iron		25	Lock - ambidextrous	12
	39018.03000.05	Burnished	Iron		30	Lock - ambidextrous	12
	39018.03000.27	Old iron	Iron		30	Lock - ambidextrous	12
	39019.04000.17	Polish brass effect	Iron	40x22	40	Small lock box	12
	39020.01000.17	Polish brass effect	Iron	1000		Hexagonal rod for lock	20
	39020.01000.21	Raw iron	Iron	1000		Hexagonal rod for lock	20
	39020.01200.17	Polish brass effect	Iron	1200		Hexagonal rod for lock	20
	39020.01200.21	Raw iron	Iron	1200		Hexagonal rod for lock	20
	39020.01500.17	Polish brass effect	Iron	1500		Hexagonal rod for lock	20
	39020.01500.21	Raw iron	Iron	1500		Hexagonal rod for lock	20
 <p>PITCH T Large size key</p>	39021.02000.17	Polish brass effect	Iron		20	Lock and accessories R-L	10
	39021.02000.21	Raw iron	Iron		20	Lock and accessories R-L	10
	39021.02500.17	Polish brass effect	Iron		25	Lock and accessories R-L	10
	39021.02500.21	Raw iron	Iron		25	Lock and accessories R-L	10
	39021.03000.17	Polish brass effect	Iron		30	Lock and accessories R-L	10
	39021.03000.21	Raw iron	Iron		30	Lock and accessories R-L	10

Photo	Code	Finish description	Mat.	Measures mm		Description	Box Pcs
				Size	Ø / C to C		
	39023.025D0.27	Old iron	Iron		25	Recessed lock R	12
	39023.025S0.27	Old iron	Iron		25	Recessed lock L	12
	39023.030D0.27	Old iron	Iron		30	Recessed lock R	12
	39023.030S0.27	Old iron	Iron		30	Recessed lock L	12
	39023.035D0.27	Old iron	Iron		35	Recessed lock R	12
	39023.035S0.27	Old iron	Iron		35	Recessed lock L	12
	39023.040D0.27	Old iron	Iron		40	Recessed lock R	12
	39023.040S0.27	Old iron	Iron		40	Recessed lock L	12
	39023.045D0.27	Old iron	Iron		45	Recessed lock R	12
	39023.045S0.27	Old iron	Iron		45	Recessed lock L	12
	39023.050D0.27	Old iron	Iron		50	Recessed lock R	12
	39023.050S0.27	Old iron	Iron		50	Recessed lock L	12
	39023.055D0.27	Old iron	Iron		55	Recessed lock R	12
	39023.055S0.27	Old iron	Iron		55	Recessed lock L	12
	39023.060D0.27	Old iron	Iron		60	Recessed lock R	12
	39023.060S0.27	Old iron	Iron		60	Recessed lock L	12
	39023.065D0.27	Old iron	Iron		65	Recessed lock R	12
	39023.065S0.27	Old iron	Iron		65	Recessed lock L	12
	39023.070D0.27	Old iron	Iron		70	Recessed lock R	12
	39023.070S0.27	Old iron	Iron		70	Recessed lock L	12
	39023.075D0.27	Old iron	Iron		75	Recessed lock R	12
	39023.075S0.27	Old iron	Iron		75	Recessed lock L	12
	39023.080D0.27	Old iron	Iron		80	Recessed lock R	12
	39023.080S0.27	Old iron	Iron		80	Recessed lock L	12
	39023.085D0.27	Old iron	Iron		85	Recessed lock R	12
	39023.085S0.27	Old iron	Iron		85	Recessed lock L	12
	39023.090D0.27	Old iron	Iron		90	Recessed lock R	12
	39023.090S0.27	Old iron	Iron		90	Recessed lock L	12
	39023.095D0.27	Old iron	Iron		95	Recessed lock R	12
	39023.095S0.27	Old iron	Iron		95	Recessed lock L	12
39023.100D0.27	Old iron	Iron		100	Recessed lock R	12	
39023.100S0.27	Old iron	Iron		100	Recessed lock L	12	

PITCH T Large size key

Photo	Code	Finish description	Mat.	Measures mm		Description	Box Pcs
				Size	Ø / C to C		
	39023.110D0.27	Old iron	Iron		110	Recessed lock R	12
	39023.110S0.27	Old iron	Iron		110	Recessed lock L	12
	39023.120D0.27	Old iron	Iron		120	Recessed lock R	12
	39023.120S0.27	Old iron	Iron		120	Recessed lock L	12
PITCH T Large size key							
	39024.025D0.27	Old iron	Iron		25	Lock R	12
	39024.025S0.27	Old iron	Iron		25	Lock L	12
	39024.030D0.27	Old iron	Iron		30	Lock R	12
	39024.030S0.27	Old iron	Iron		30	Lock L	12
	39024.035D0.27	Old iron	Iron		35	Lock R	12
	39024.035S0.27	Old iron	Iron		35	Lock L	12
	39024.040D0.27	Old iron	Iron		40	Lock R	12
	39024.040S0.27	Old iron	Iron		40	Lock L	12
	39024.045D0.27	Old iron	Iron		45	Lock R	12
	39024.045S0.27	Old iron	Iron		45	Lock L	12
	39024.050D0.27	Old iron	Iron		50	Lock R	12
	39024.050S0.27	Old iron	Iron		50	Lock L	12
	39024.060D0.27	Old iron	Iron		60	Lock R	12
	39024.060S0.27	Old iron	Iron		60	Lock L	12
	39024.070D0.27	Old iron	Iron		70	Lock R	12
	39024.070S0.27	Old iron	Iron		70	Lock L	12
	39024.080D0.27	Old iron	Iron		80	Lock R	12
	39024.080S0.27	Old iron	Iron		80	Lock L	12
	39024.090D0.27	Old iron	Iron		90	Lock R	12
	39024.090S0.27	Old iron	Iron		90	Lock L	12
	39024.100D0.27	Old iron	Iron		100	Lock R	12
	39024.100S0.27	Old iron	Iron		100	Lock L	12
	39024.110D0.27	Old iron	Iron		110	Lock R	12
	39024.110S0.27	Old iron	Iron		110	Lock L	12
39024.120D0.27	Old iron	Iron		120	Lock R	12	
39024.120S0.27	Old iron	Iron		120	Lock L	12	
PITCH T Large size key							



Photo	Code	Finish description	Mat.	Measures mm		Description	Box Pcs
				Size	Ø / C to C		
	39025.025D0.17	Polish brass effect	Iron		25	Full inset lock	12
 PITCH T Large size key	39026.05000.27	Old iron	Iron		50	Lock	12
	39026.06500.27	Old iron	Iron		65	Lock	12
	39026.08000.27	Old iron	Iron		80	Lock	12
	39031.03500.17	Polish brass effect	Zamak	35x15		Lock rod guide	20
	39031.03500.21	Raw iron	Zamak	35x15		Lock rod guide	20
	39032.02000.17	Polish brass effect	Iron	20	10	Barrel	20
	39032.02000.21	Raw iron	Iron	20	10	Barrel	20
 PITCH N Small size key	39033.02000.17	Polish brass effect	Iron		20	Lock and accessories R-L	10
	39033.02000.21	Raw iron	Iron		20	Lock and accessories R-L	10
	39033.02500.17	Polish brass effect	Iron		25	Lock and accessories R-L	10
	39033.02500.21	Raw iron	Iron		25	Lock and accessories R-L	10
	39033.03000.17	Polish brass effect	Iron		30	Lock and accessories R-L	10
	39033.03000.21	Raw iron	Iron		30	Lock and accessories R-L	10
 PITCH N Small size key	39037.01500.27	Old iron	Iron	30x110	15	Lock - ambidextrous	12
	39037.02000.27	Old iron	Iron	40x110	20	Lock - ambidextrous	12
	39037.02500.27	Old iron	Iron	50x110	25	Lock - ambidextrous	12
	39037.03000.27	Old iron	Iron	60x110	30	Lock - ambidextrous	12
 PITCH N Small size key	39038.10000.27	Old iron	Iron	100x70		Padlock	1







Photo	Code	Finish description	Mat.	Measures mm		Description	Box Pcs
				Size	Ø / C to C		
	39040.01500.05	Burnished	Iron		15	Lock R-L	10
	39040.01500.17	Polish brass effect	Iron		15	Lock R-L	10
	39027.01000.CB	Nera	Iron	1000		Half-moon rod for lock 39040	20
	39027.01000.17	Polish brass effect	Iron	1000		Half-moon rod for lock 39040	20
	39027.01200.CB	Nera	Iron	1200		Half-moon rod for lock 39040	20
	39027.01200.17	Polish brass effect	Iron	1200		Half-moon rod for lock 39040	20
 <p>PITCH T Large size key</p>	39044.19500.27	Old iron	Iron		55	Recessed chest lock	4
	39073.04800.11	Polish brass	Brass	48x32		Button	25
	39074.10000.27	Old iron	Iron	100x25		Spring for cupboard	50
	39075.045D0.27	Old iron	Iron	45		Hook with eye R	50
	39075.045S0.27	Old iron	Iron	45		Hook with eye L	50
	39075.050D0.27	Old iron	Iron	50		Hook with eye R	50
	39075.050S0.27	Old iron	Iron	50		Hook with eye L	50
	39075.060D0.27	Old iron	Iron	60		Hook with eye R	50
	39075.060S0.27	Old iron	Iron	60		Hook with eye L	50
	39075.075D0.27	Old iron	Iron	75		Hook with eye R	50
	39075.075S0.27	Old iron	Iron	75		Hook with eye L	50

Photo	Code	Finish description	Mat.	Measures mm		Description	Box Pcs
				Size	Ø / C to C		
	39076.085D0.27	Old iron	Iron	85x25		Forged hook R	25
	39076.085S0.27	Old iron	Iron	85x25		Forged hook L	25
	39090.02000.27	Old iron	Iron		20	Recessed lock with joint	12
	39090.02000.21	Raw iron	Iron		20	Recessed lock with joint	12
	39090.02500.27	Old iron	Iron		25	Recessed lock with joint	12
	39090.02500.21	Raw iron	Iron		25	Recessed lock with joint	12
	39090.03000.27	Old iron	Iron		30	Recessed lock with joint	12
	39090.03000.21	Raw iron	Iron		30	Recessed lock with joint	12
	39090.03500.27	Old iron	Iron		35	Recessed lock with joint	12
	39090.03500.21	Raw iron	Iron		35	Recessed lock with joint	12
	39090.04000.27	Old iron	Iron		40	Recessed lock with joint	12
	39090.04000.21	Raw iron	Iron		40	Recessed lock with joint	12
	39090.05000.27	Old iron	Iron		50	Recessed lock with joint	12
	39090.05000.21	Raw iron	Iron		50	Recessed lock with joint	12
	39090.06000.27	Old iron	Iron		60	Recessed lock with joint	12
	39090.06000.21	Raw iron	Iron		60	Recessed lock with joint	12
PITCH N Small size key							
	39091.01500.27	Old iron	Iron		15	Lock R-L	12
	39091.01500.21	Raw iron	Iron		15	Lock R-L	12
	39091.02000.27	Old iron	Iron		20	Lock R-L	12
	39091.02000.21	Raw iron	Iron		20	Lock R-L	12
	39091.02500.27	Old iron	Iron		25	Lock R-L	12
	39091.02500.21	Raw iron	Iron		25	Lock R-L	12
	39091.03000.27	Old iron	Iron		30	Lock R-L	12
	39091.03000.21	Raw iron	Iron		30	Lock R-L	12
	39091.03500.27	Old iron	Iron		35	Lock R-L	12
	39091.03500.21	Raw iron	Iron		35	Lock R-L	12
	39091.04000.27	Old iron	Iron		40	Lock R-L	12
	39091.04000.21	Raw iron	Iron		40	Lock R-L	12
	39091.04500.27	Old iron	Iron		45	Lock R-L	12
PITCH N Small size key							





Photo	Code	Finish description	Mat.	Measures mm		Description	Box Pcs
				Size	Ø / C to C		
 <p>PITCH N Small size key</p>	39091.04500.21	Raw iron	Iron		45	Lock R-L	12
	39091.05000.27	Old iron	Iron		50	Lock R-L	12
	39091.05000.21	Raw iron	Iron		50	Lock R-L	12
	39091.06000.27	Old iron	Iron		60	Lock R-L	12
	39091.06000.21	Raw iron	Iron		60	Lock R-L	12
	39091.07000.27	Old iron	Iron		70	Lock R-L	12
	39091.07000.21	Raw iron	Iron		70	Lock R-L	12
	39091.08000.27	Old iron	Iron		80	Lock R-L	12
	39091.08000.21	Raw iron	Iron		80	Lock R-L	12
	39093.03000.27	Old iron	Iron	14x30		Threaded hook	100
	39093.04000.27	Old iron	Iron	16x40		Threaded hook	100
	39093.04500.27	Old iron	Iron	19x45		Threaded hook	100
	39093.06000.27	Old iron	Iron	25x60		Threaded hook	100
	39094.05100.27	Old iron	Iron	31x51		Oval screw eye	50
	39095.02500.27	Old iron	Iron	19x25		Hook for window	100
	39095.03500.27	Old iron	Iron	20x35		Hook for window	100
	39095.04500.27	Old iron	Iron	27x45		Hook for window	100
	39096.02900.27	Old iron	Iron	12x29		Screw eye	100
	39096.03300.27	Old iron	Iron	14x33		Screw eye	100
	39096.04400.27	Old iron	Iron	18x44		Screw eye	100
	39096.05200.27	Old iron	Iron	21x52		Screw eye	100
	39096.06500.27	Old iron	Iron	24x65		Screw eye	100

Photo	Code	Finish description	Mat.	Measures mm		Description	Box Pcs
				Size	Ø / C to C		
	39097.08000.27	Old iron	Iron	19x80		Hook for window with screw eye	50
	39097.10000.27	Old iron	Iron	24x100		Hook for window with screw eye	50
	39097.12000.27	Old iron	Iron	27x120		Hook for window with screw eye	50
	39101.12000.32C	Bright chrome	Brass	120x45		Lock for icebox	1
	39101.12000.03C	Antique brass	Brass	120x45		Lock for icebox	1
	39101.12500.32C	Bright chrome	Brass	125x60		Lock for icebox	1
	39101.12500.03C	Antique brass	Brass	125x60		Lock for icebox	1
	39105.10000.32C	Bright chrome	Brass	100x45		Lock for icebox	1
	48160.10500.32C	Bright chrome	Brass	105x20		Flat hinge for icebox	1
	48160.10500.03C	Antique brass	Brass	105x20		Flat hinge for icebox	1
	48160.08000.32C	Bright chrome	Brass	80x18		Flat hinge for icebox	1
	48160.08000.03C	Antique brass	Brass	80x18		Flat hinge for icebox	1
 <p>PITCH N Small size key</p>	39115.02000.27	Old iron	Iron		20	Lock R-L	12
	39115.02500.27	Old iron	Iron		25	Lock R-L	12
	39115.030D0.27	Old iron	Iron		30	Lock R	12
	39115.030S0.27	Old iron	Iron		30	Lock L	12
	46006.08000.03	Antique brass	Iron	80x40		Latch	50
	46006.08000.05	Burnished	Iron	80x40		Latch	50
	46006.08000.27	Old iron	Iron	80x40		Latch	50
	46006.09500.03	Antique brass	Iron	95x40		Latch	50
	46006.09500.05	Burnished	Iron	95x40		Latch	50
	46006.09500.27	Old iron	Iron	95x40		Latch	50

Photo	Code	Finish description	Mat.	Measures mm		Description	Box Pcs
				Size	Ø / C to C		
	46007.07000.03	Antique brass	Iron	70x30		Latch	50
	46007.07000.05	Burnished	Iron	70x30		Latch	50
	46007.07000.27	Old iron	Iron	70x30		Latch	50
	46007.10000.03	Antique brass	Iron	100x30		Latch	50
	46007.10000.05	Burnished	Iron	100x30		Latch	50
	46007.10000.27	Old iron	Iron	100x30		Latch	50
	46007.20000.03	Antique brass	Iron	200x30		Latch	25
	46007.20000.05	Burnished	Iron	200x30		Latch	25
	46007.20000.27	Old iron	Iron	200x30		Latch	25
	46009.09500.27	Old iron	Iron	95x40		Latch	10
	47001.08000.27	Old iron	Iron	80x60		Latch	10
	50011.045D0.27	Old iron	Iron		45	Iron lock R	4
	50011.045S0.27	Old iron	Iron		45	Iron lock L	4
	50011.065D0.27	Old iron	Iron		65	Iron lock R	4
	50011.065S0.27	Old iron	Iron		65	Iron lock L	4
	50011.095D0.27C	Old iron	Iron		95	Iron lock R	4
	50011.095S0.27C	Old iron	Iron		95	Iron lock L	4

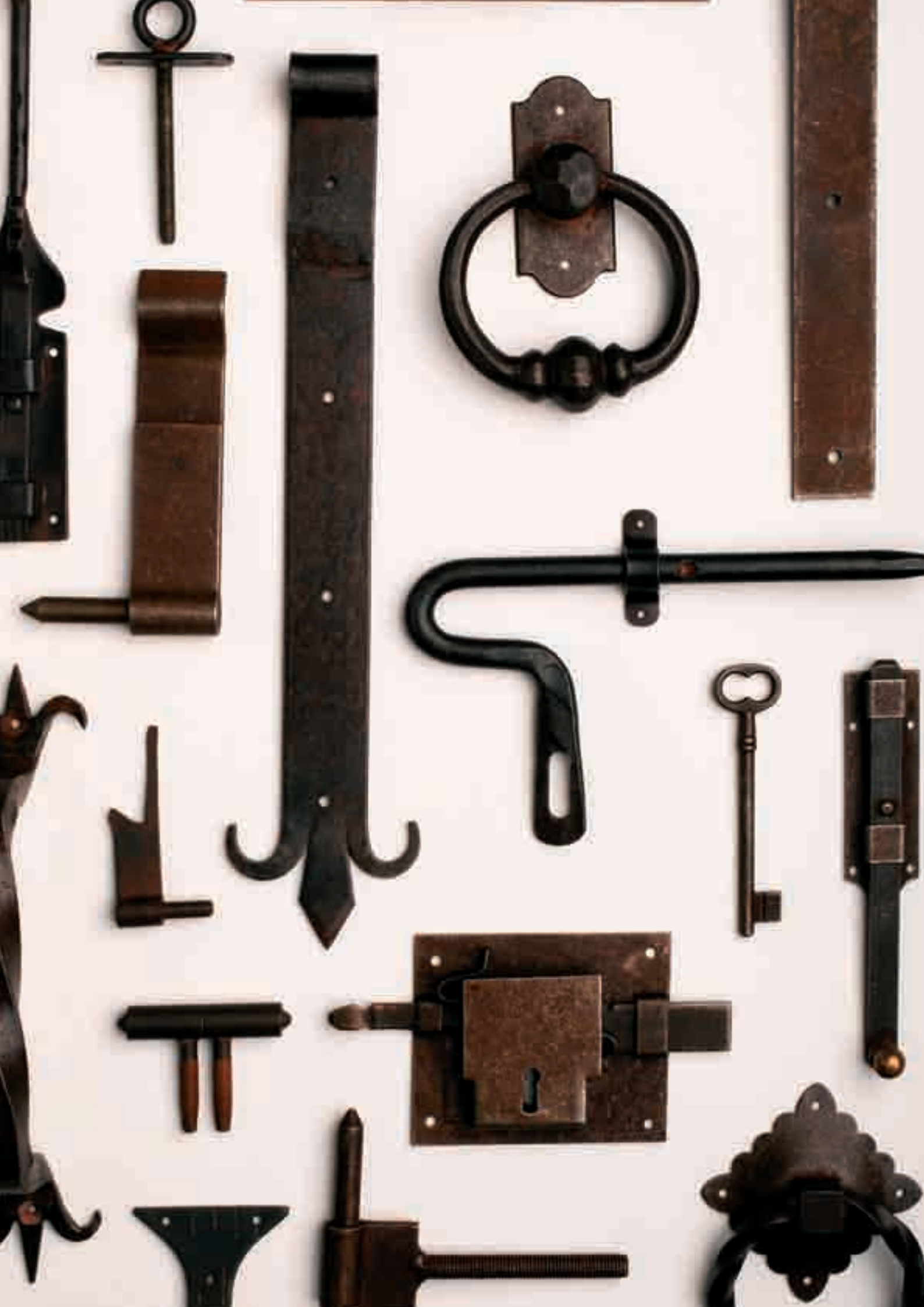











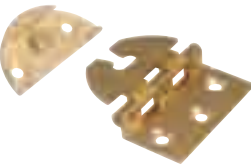



Photo	Code	Finish description	Mat.	Measures mm		Description	Box Pcs
				Size	Ø / C to C		
Hinges							
	39082.18000.27	Old iron	Iron	180x35		Locking hinge	4
	39082.24000.27	Old iron	Iron	240x35		Locking hinge	4
	39102.21600.27	Old iron	Iron	216x32		Locking hinge	25
	39114.15000.27	Old iron	Iron	150X52		Locking hinge	25
	48010.10000.27	Old iron	Iron	100x55		Flat hinge	10
	48010.12500.27	Old iron	Iron	125x70		Flat hinge	10
	48010.15000.27	Old iron	Iron	150x90		Flat hinge	10
	48011.10000.27	Old iron	Iron	100x29		Flat hinge	10
	48011.15000.27	Old iron	Iron	150x29		Flat hinge	10
	48011.20000.27	Old iron	Iron	200x37		Flat hinge	10
	48014.02500.17C	Polish brass effect	Iron	25x13		Flat box hinge	25
	48015.02500.40	Natural brass	Brass	25x25		Flat hinge	24
	48015.02500.04C	Bronzed	Brass	25x25		Flat hinge	24
	48015.03000.04C	Bronzed	Brass	30x30		Flat hinge	24
	48015.03000.40	Natural brass	Brass	30x30		Flat hinge	24
	48015.03500.04C	Bronzed	Brass	35x35		Flat hinge	24
	48015.03500.40	Natural brass	Brass	35x35		Flat hinge	24
	48015.04000.04C	Bronzed	Brass	40x40		Flat hinge	24
	48015.04000.40	Natural brass	Brass	40x40		Flat hinge	24
	48015.05000.04C	Bronzed	Brass	50x50		Flat hinge	24
	48015.05000.40	Natural brass	Brass	50x50		Flat hinge	24

Photo	Code	Finish description	Mat.	Measures mm		Description	Box Pcs	
				Size	Ø / C to C			
	48019.03000.27	Old iron	Iron	30x22		Flat hinge	50	
	48019.04000.27	Old iron	Iron	40x25		Flat hinge	50	
	48019.05000.27	Old iron	Iron	50x30		Flat hinge	50	
	48021.01000.40	Natural brass	Brass		diam. 10	Recessed hinge	24	
	48021.01200.40	Natural brass	Brass		diam. 12	Recessed hinge	24	
	48021.01400.40	Natural brass	Brass		diam. 14	Recessed hinge	24	
	48022.04000.40	Natural brass	Brass	40x40		Flat hinge	25	
	48022.04000.03	Antique brass	Brass	40x40		Flat hinge	25	
	48023.00800.40	Natural brass	Brass	8x40x35		Fold hinge	25	
	48023.00800.03	Antique brass	Brass	8x40x35		Fold hinge	25	
	48023.01000.40	Natural brass	Brass	10x40x35		Fold hinge	25	
	48023.01000.03	Antique brass	Brass	10x40x35		Fold hinge	25	
	48023.01300.40	Natural brass	Brass	13x40x35		Fold hinge	25	
	48023.01300.03	Antique brass	Brass	13x40x35		Fold hinge	25	
	48024.08000.64	Tropicalized	Iron	80x30		Flat hinge	24	
	48026.08200.03	Antique brass	Brass	82x30		Hinge with stop	25	
	48027.18000.05	Burnished	Iron	175x65		Hinge with stop	10	
	48028.08500.27	Old iron	Iron	85x52		Flat hinge	50	

Hinges

Photo	Code	Finish description	Mat.	Measures mm		Description	Box Pcs
				Size	Ø / C to C		
	48029.15000.27	Old iron	Iron	145x55		Flat hinge	25
	48030.14000.27	Old iron	Iron	135x47		Flat hinge	25
	48030.21000.27	Old iron	Iron	210x47		Flat hinge	25
	48031.18200.27	Old iron	Iron	182x30		Flat hinge	25
	48032.15500.27	Old iron	Iron	155x25		Flat hinge	25
	48033.08800.03	Antique brass	Iron	88x52		Flat hinge	50
	48033.08800.05	Burnished	Iron	88x52		Flat hinge	50
	48033.08800.27	Old iron	Iron	88x52		Flat hinge	50
	48034.07200.03	Antique brass	Iron	75x52		Flat hinge	50
	48034.07200.27	Old iron	Iron	75x52		Flat hinge	50
	48035.15000.05	Burnished	Iron	150x60		Flat hinge	25
	48035.15000.27	Old iron	Iron	150x60		Flat hinge	25
	48036.20500.27	Old iron	Iron	205x65		Flat hinge	25

Photo	Code	Finish description	Mat.	Measures mm		Description	Box Pcs
				Size	Ø / C to C		
	48037.15000.27	Old iron	Iron	150x28		Flat hinge	25
	48038.14000.27	Old iron	Iron	135x45		Flat hinge	25
	48039.40000.27	Old iron	Iron	400x60		Flat hinge	25
	48040.30000.27	Old iron	Iron	278x60		Flat hinge	25
	48041.39000.27	Old iron	Iron	390x45		Flat hinge	25
	48042.28000.27	Old iron	Iron	280x45		Flat hinge	25
	48042.33000.27	Old iron	Iron	330x45		Flat hinge	25
	48042.38500.27	Old iron	Iron	385x45		Flat hinge	25
	48043.075D0.27	Old iron	Iron	75x45		Flat hinge dx	25
	48043.075S0.27	Old iron	Iron	75x45		Flat hinge sx	25
	48044.11000.27	Old iron	Iron	110		Forged pivot hinge	50

Hinges

Photo	Code	Finish description	Mat.	Measures mm		Description	Box Pcs
				Size	Ø / C to C		
	48045.05000.05	Burnished	Iron	50x40		Flat hinge	50
	48045.05000.27	Old iron	Iron	50x40		Flat hinge	50
	48045.07000.05	Burnished	Iron	70x40		Flat hinge	50
	48045.07000.27	Old iron	Iron	70x40		Flat hinge	50
	48046.08000.27	Old iron	Iron	80x70		Flat hinge	25
	48047.15000.27	Old iron	Iron	150x30		Flat hinge	25
	48048.07500.27	Old iron	Iron	75x75		Flat hinge ambidextrous	25
	48049.075D0.03	Antique brass	Iron	40x75		Fold hinge R	25
	48049.075D0.27	Old iron	Iron	40x75		Fold hinge R	25
	48049.075S0.03	Antique brass	Iron	40x75		Fold hinge L	25
	48049.075S0.27	Old iron	Iron	40x75		Fold hinge L	25
	48049.095D0.03	Antique brass	Iron	60x95		Fold hinge R	25
	48049.095D0.27	Old iron	Iron	60x95		Fold hinge R	25
	48049.095S0.03	Antique brass	Iron	60x95		Fold hinge L	25
	48049.095S0.27	Old iron	Iron	60x95		Fold hinge L	25
	48050.075D0.03	Antique brass	Iron	40x75		Flat hinge R	25
	48050.075D0.27	Old iron	Iron	40x75		Flat hinge R	25
	48050.075S0.03	Antique brass	Iron	40x75		Flat hinge L	25
	48050.075S0.27	Old iron	Iron	40x75		Flat hinge L	25
	48050.095D0.03	Antique brass	Iron	60x95		Flat hinge R	25
	48050.095D0.27	Old iron	Iron	60x95		Flat hinge R	25
	48050.095S0.03	Antique brass	Iron	60x95		Flat hinge L	25
	48050.095S0.27	Old iron	Iron	60x95		Flat hinge L	25

Photo	Code	Finish description	Mat.	Measures mm		Description	Box Pcs
				Size	Ø / C to C		
	48051.080D0.03	Antique brass	Brass	50x80		Fold hinge R	25
	48051.080S0.03	Antique brass	Brass	50x80		Fold hinge L	25
	48052.080D0.03	Antique brass	Brass	50x80		Flat hinge R	25
	48052.080S0.03	Antique brass	Brass	50x80		Flat hinge L	25
	48058.080D0.03	Antique brass	Iron	40x80		Fold hinge R	25
	48058.080D0.27	Old iron	Iron	40x80		Fold hinge R	25
	48058.080S0.03	Antique brass	Iron	40x80		Fold hinge L	25
	48058.080S0.27	Old iron	Iron	40x80		Fold hinge L	25
	48058.100D0.03	Antique brass	Iron	60x100		Fold hinge R	25
	48058.100D0.27	Old iron	Iron	60x100		Fold hinge R	25
	48058.100S0.03	Antique brass	Iron	60x100		Fold hinge L	25
	48058.100S0.27	Old iron	Iron	60x100		Fold hinge L	25
	48059.080D0.03	Antique brass	Iron	40x80		Flat hinge R	25
	48059.080D0.27	Old iron	Iron	40x80		Flat hinge R	25
	48059.080S0.03	Antique brass	Iron	40x80		Flat hinge L	25
	48059.080S0.27	Old iron	Iron	40x80		Flat hinge L	25
	48059.100D0.03	Antique brass	Iron	60x100		Flat hinge R	25
	48059.100D0.27	Old iron	Iron	60x100		Flat hinge R	25
	48059.100S0.03	Antique brass	Iron	60x100		Flat hinge L	25
	48059.100S0.27	Old iron	Iron	60x100		Flat hinge L	25
	48063.13500.27	Old iron	Iron	135x55		Rustic hinge	25
	48064.11000.27	Old iron	Iron	110x16		Rustic hinge	25

Hinges

Photo	Code	Finish description	Mat.	Measures mm		Description	Box Pcs
				Size	Ø / C to C		
	48065.11500.27	Old iron	Iron	155x85	8	Rustic hinge	10
	48065.10500.21	Raw iron	Iron	105X55	8	Rustic hinge	10
	48065.10500.27	Old iron	Iron	105X55	8	Rustic hinge	10
	48069.04000.03	Antique brass	Brass		40	Flat hinge	25
	48070.17500.27	Old iron	Iron	175x40		Forged Flat hinge	10
	48070.24000.27	Old iron	Iron	240x50		Forged Flat hinge	10
	48071.05000.40	Brass	Brass	50x40		Fold hinge	25
	48074.105D0.03	Antique brass	Iron	70x105		Fold hinge R	25
	48074.105D0.27	Old iron	Iron	70x105		Fold hinge R	25
	48074.105S0.03	Antique brass	Iron	70x105		Fold hinge L	25
	48074.105S0.27	Old iron	Iron	70x105		Fold hinge L	25
	48075.105D0.27	Old iron	Iron	70x105		Fold hinge - brass cap R	25
	48075.105S0.27	Old iron	Iron	70x105		Fold hinge - brass cap L	25
	48076.105D0.03	Antique brass	Iron	70x105		Off-set hinge R	25
	48076.105D0.27	Old iron	Iron	70x105		Off-set hinge R	25
	48076.105S0.03	Antique brass	Iron	70x105		Off-set hinge L	25
	48076.105S0.27	Old iron	Iron	70x105		Off-set hinge L	25
	48077.105D0.27	Old iron	Iron	70x105		Off-set hinge - brass cap R	25
	48077.105S0.27	Old iron	Iron	70x105		Off-set hinge - brass cap L	25

Photo	Code	Finish description	Mat.	Measures mm		Description	Box Pcs
				Size	Ø / C to C		
	48078.085D0.03	Antique brass	Iron	50x85		Off-set hinge R	25
	48078.085D0.27	Old iron	Iron	50x85		Off-set hinge R	25
	48078.085S0.03	Antique brass	Iron	50x85		Off-set hinge L	25
	48078.085S0.27	Old iron	Iron	50x85		Off-set hinge L	25
	48078.115D0.03	Antique brass	Iron	70x115		Off-set hinge R	25
	48078.115D0.27	Old iron	Iron	70x115		Off-set hinge R	25
	48078.115S0.03	Antique brass	Iron	70x115		Off-set hinge L	25
	48078.115S0.27	Old iron	Iron	70x115		Off-set hinge L	25
	48079.085D0.03	Antique brass	Iron	50x85		Centred hinge R	25
	48079.085D0.27	Old iron	Iron	50x85		Centred hinge R	25
	48079.085S0.03	Antique brass	Iron	50x85		Centred hinge L	25
	48079.085S0.27	Old iron	Iron	50x85		Centred hinge L	25
	48079.115D0.03	Antique brass	Iron	70x115		Centred hinge R	25
	48079.115D0.27	Old iron	Iron	70x115		Centred hinge R	25
	48079.115S0.03	Antique brass	Iron	70x115		Centred hinge L	25
	48079.115S0.27	Old iron	Iron	70x115		Centred hinge L	25
	48080.085D0.03	Antique brass	Iron	50x85		Fold hinge R	25
	48080.085D0.27	Old iron	Iron	50x85		Fold hinge R	25
	48080.085S0.03	Antique brass	Iron	50x85		Fold hinge L	25
	48080.085S0.27	Old iron	Iron	50x85		Fold hinge L	25
	48080.115D0.03	Antique brass	Iron	70x115		Fold hinge R	25
	48080.115D0.27	Old iron	Iron	70x115		Fold hinge R	25
	48080.115S0.03	Antique brass	Iron	70x115		Fold hinge L	25
	48080.115S0.27	Old iron	Iron	70x115		Fold hinge L	25
	48081.12500.21	Raw iron	Iron	125x45		Hinge with stop	10
	48081.12500.27	Old iron	Iron	125x45		Hinge with stop	10
	48081.15500.21	Raw iron	Iron	155x48		Hinge with stop	10
	48081.15500.27	Old iron	Iron	155x48		Hinge with stop	10
	48082.39000.21	Raw iron	Iron	390x30		Forged flat hinge	10

Hinges

Photo	Code	Finish description	Mat.	Measures mm		Description	Box Pcs
				Size	Ø / C to C		
	48083.16000.27	Old iron	Iron	160x30		Forged Flat hinge	10
	48083.22000.27	Old iron	Iron	220x45		Forged Flat hinge	10
	48093.13500.27	Old iron	Iron	135x45		Flat hinge	25
	48094.16700.27	Old iron	Iron	167x50		Flat hinge	25
	48096.140D0.03	Antique brass	Iron	70x140		Fold hinge R	25
	48096.140D0.27	Old iron	Iron	70x140		Fold hinge R	25
	48096.140S0.03	Antique brass	Iron	70x140		Fold hinge L	25
	48096.140S0.27	Old iron	Iron	70x140		Fold hinge L	25
	48096.170D0.03	Antique brass	Iron	70x170		Fold hinge R	25
	48096.170D0.27	Old iron	Iron	70x170		Fold hinge R	25
	48096.170S0.03	Antique brass	Iron	70x170		Fold hinge L	25
	48096.170S0.27	Old iron	Iron	70x170		Fold hinge L	25
	48097.095D0.03	Antique brass	Iron	60x95		Fold hinge R	25
	48097.095D0.27	Old iron	Iron	60x95		Fold hinge R	25
	48097.095S0.03	Antique brass	Iron	60x95		Fold hinge L	25
	48097.095S0.27	Old iron	Iron	60x95		Fold hinge L	25
	48097.120D0.03	Antique brass	Iron	80x120		Fold hinge R	25
	48097.120D0.27	Old iron	Iron	80x120		Fold hinge R	25
	48097.120S0.03	Antique brass	Iron	80x120		Fold hinge L	25
	48097.120S0.27	Old iron	Iron	80x120		Fold hinge L	25
	48098.01200.03	Antique brass	Iron	9x12		Hinge	100
	48098.01200.05	Burnished	Iron	9x12		Hinge	100
	48098.01200.27	Old iron	Iron	9x12		Hinge	100

Photo	Code	Finish description	Mat.	Measures mm		Description	Box Pcs
				Size	Ø / C to C		
	48100.03600.DD	Special bronze	Iron	9x36		Hinge	100
	48102.05500.03	Antique brass	Iron	9x55		Hinge	100
	48102.05500.27	Old iron	Iron	9x55		Hinge	100
	48102.06600.03	Antique brass	Iron	9x66		Hinge	100
	48102.06600.27	Old iron	Iron	9x66		Hinge	100
	48103.07800.03	Antique brass	Iron	11x78		Hinge	100
	48105.04500.03	Antique brass	Iron	9x45		Hinge	100
	48105.04500.27	Old iron	Iron	9x45		Hinge	100
	48105.06500.03	Antique brass	Iron	9x65		Hinge	100
	48105.06500.27	Old iron	Iron	9x65		Hinge	100
	48105.08000.03	Antique brass	Iron	9x80		Hinge	100
	48105.08000.27	Old iron	Iron	9x80		Hinge	100
	48106.10000.03	Antique brass	Iron	10x90		Hinge	50
	48106.10000.27	Old iron	Iron	10x90		Hinge	50
	48107.12000.03	Antique brass	Iron	9x120		Hinge	50
	48107.12000.27	Old iron	Iron	9x120		Hinge	50
	48109.10000.03	Antique brass	Iron	9x100		Hinge	50
	48109.10000.27	Old iron	Iron	9x100		Hinge	50
	48108.12000.03	Antique brass	Iron	11x120		Hinge	50
	48110.10000.03	Antique brass	Iron	11x100		Hinge	50
	48110.10000.27	Old iron	Iron	11x100		Hinge	50

Hinges















Photo	Code	Finish description	Mat.	Measures mm		Description	Box Pcs
				Size	Ø / C to C		
	48120.10500.05	Burnished	Iron	105		hinge	100
	48121.10500.05	Burnished	Iron	105		Pivot hinge	100
	48125.140D0.03	Antique brass	Iron	70x140		Flat hinge R	25
	48125.140D0.27	Old iron	Iron	70x140		Flat hinge R	25
	48125.140S0.03	Antique brass	Iron	70x140		Flat hinge L	25
	48125.140S0.27	Old iron	Iron	70x140		Flat hinge L	25
	48127.102D0.27	Old iron	Iron	102x47		Centred finital hinge R	25
	48127.102S0.27	Old iron	Iron	102x47		Centred finital hinge L	25
	48127.127D0.27	Old iron	Iron	127x55		Centred finital hinge R	25
	48127.127S0.27	Old iron	Iron	127x55		Centred finital hinge L	25
	48129.06500.03	Antique brass	Brass	65x40		Adjustable fold hinge	50
	48130.06500.03	Antique brass	Brass	65x40		Adjustable flat hinge	50
	48143.07000.21	Raw iron	Iron	70		Pivot hinge	50
	48144.11000.21	Raw iron	Iron	160		Double pivot hinge	100
	48144.20500.21	Raw iron	Iron	205		Double pivot hinge	100
	48144.22500.21	Raw iron	Iron	225		Double pivot hinge	24

Photo	Code	Finish description	Mat.	Measures mm		Description	Box Pcs
				Size	Ø / C to C		
	48147.10500.21	Raw iron	Iron	105		Pivot hinge	25
	48151Z07200.09	Florence	Zamak	50x72		Adjustable fold hinge	50
	48151Z07200.10	Polish brass effect	Zamak	50x72		Adjustable fold hinge	50
	48153Z10400.09	Florence	Zamak	50x105		Adjustable fold hinge	50
	48153Z10400.10	Polish brass effect	Zamak	50x105		Adjustable fold hinge	50
	48155Z08000.09	Florence	Zamak	50x80		Adjustable fold hinge	50
	48155Z08000.10	Polish brass effect	Zamak	50x80		Adjustable fold hinge	50
	48158.21600.27	Old iron	Iron	216x32		Flat hinge	25
	48167.06300.27	Old iron	Iron	63X63		Flat hinge	10
	48167.07600.27	Old iron	Iron	76x76		Flat hinge	10
	48167.08900.27	Old iron	Iron	89X89		Flat hinge	10
	48167.10000.27	Old iron	Iron	100x100		Flat hinge	10
	48167.12700.27	Old iron	Iron	127X127		Flat hinge	6
	48168.04000.27	Old iron	Iron	50x40		Flat hinge	24
	48168.04300.27	Old iron	Iron	57x43		Flat hinge	24
	48168.05000.27	Old iron	Iron	70x50		Flat hinge	24
	48168.05800.27	Old iron	Iron	87x58		Flat hinge	24
	48168.07000.27	Old iron	Iron	70x100		Flat hinge	12

Hinges





Photo	Code	Finish description	Mat.	Measures mm		Description	Box Pcs
				Size	Ø / C to C		
	48185Z03500.03	Antique brass	Zamak	18x35		Flat hinge	50
	48186Z03500.03	Antique brass	Zamak		35	Flat hinge	50
	48187.15000.27	Old iron	Iron	150X52		Flat hinge with hole	25
 R	49009.250D0.04	Bronzed	Brass	250		Stay R	2
	49009.250D0.66	Shining brass	Brass	250		Stay R	2
 L	49009.250S0.04	Bronzed	Brass	250		Stay L	2
	49009.250S0.66	Shining brass	Brass	250		Stay L	2

Photo	Code	Finish description	Mat.	Measures mm		Description	Box Pcs
				Size	Ø / C to C		
Small hardware							
	39028.08000.33	Zinc plated	Iron	80		Lever Closure	100
	39028.10000.33C	Zinc plated	Iron	100		Lever Closure	100
	39078.04800.G1	Brown	Plastic	46x15		Magnetic catch	100
	39080.03000.G1	Brown	Plastic	30x25		Magnetic catch	100
	39083.08500.27	Old iron	Iron	85x33		Through joint for closing	4
	39084.04000.27	Old iron	Iron	40x33		Mordant joint for closing	4
	39085.03200.DC	French bronzed	Iron	30x32		Ratchet with roller	100
	39086.04400.66	Shining brass	Brass	8x44		Ratchet with roller adjustable	50
	39086.04900.66	Shining brass	Brass	9x49		Ratchet with roller adjustable	50
	39087.03300.40C	Zinc plated	Steel	26x33x11		Mini latch automatic spring catch white plastic	25
	39087.03301.40C	Zinc plated	Steel	26x33x11		Mini latch automatic spring catch white plastic	25

Photo	Code	Finish description	Mat.	Measures mm		Description	Box Pcs
				Size	Ø / C to C		
	39088.02500.17C	Polish brass effect	Iron	25x20		Small box lock	4
	39108.09000.G1C	Brown	Plastic	90x15		Double magnetic catch	10
	39109.04200.P1C	Brown	Plastic		42	Magnetic push clamp	25
	39113.03000.66C	Shining brass	Brass	30x25		Small box lock	25
	48014.02500.17C	Polish brass effect	Iron	25x13		Flat box hinge	25
	41007Z06400.21	Raw iron	Zamak	35x17x64	M8	Joint	100
	41007Z08400.21	Raw iron	Zamak	35x17x84	M8	Joint	100
	41009.09500.21C	Raw iron	Iron	95		Joint for beds	5
	41009.15000.21C	Raw iron	Iron	150		Joint for beds	5
	41011.12000.64	Tropicalized	Iron	130		Joint for beds	6



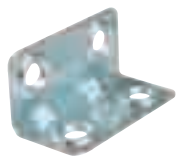

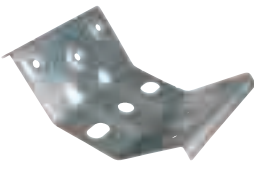

Photo	Code	Finish description	Mat.	Measures mm		Description	Box Pcs
				Size	Ø / C to C		
	41012Z04000.17	Polish brass effect	Zamak	39x15		Joint	100
	41019.04000.33	Zinc plated	Iron	40x15		Plate	50
	41019.06000.33	Zinc plated	Iron	60x15		Plate	50
	41019.08000.33	Zinc plated	Iron	80x15		Plate	50
	41020.02000.33	Zinc plated	Iron	20x20		Plate	50
	41020.03000.33	Zinc plated	Iron	30x30		Plate	50
	41020.04000.33	Zinc plated	Iron	40x40		Plate	50
	41020.05000.33	Zinc plated	Iron	50x50		Plate	50
	41021.04000.33	Zinc plated	Iron	20x20x37		Corner	50
	41022.02800.64	Tropicalized	Iron	25x25		Corner	50
	41023.13300.33	Zinc plated	Steel	133x89		Strait corner for table	50
	41024.14300.33	Zinc plated	Steel	143x85		Strait corner for table	50
	41025.14800.33	Zinc plated	Steel	148x85		Large corner for table	50

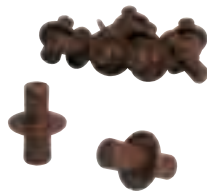



Photo	Code	Finish description	Mat.	Measures mm		Description	Box Pcs
				Size	Ø / C to C		
	41026.03700.33	Zinc plated	Iron	37x37		Plate	50
	42001.02200.17	Polish brass effect	Brass	22	M5	Shelf support without thread	100
	42018.05600.G1	Brown	Plastic		M6/M5	Shelf support	200
	42022.01500.04	Bronzed	Brass	7x15	M5	Shelf support	100
	42022.01500.17	Polish brass effect	Brass	7x15	M5	Shelf support	100
	42022.02000.04	Bronzed	Brass	7x20	M5	Shelf support	100
	42022.02000.17	Polish brass effect	Brass	7x20	M5	Shelf support	100
	42022.02400.04	Bronzed	Brass	7x24	M5	Shelf support	100
	42022.02400.17	Polish brass effect	Brass	7x24	M5	Shelf support	100
	42023.01000.17	Polish brass effect	Brass	7x16	M5	Shelf support	100
	42023.02000.17	Polish brass effect	Brass	7x20	M5	Shelf support	100
	42023.02500.17	Polish brass effect	Brass	7x25	M5	Shelf support	100
	42028.01500.G1	Brown	Plastic		15	Shelf support	200
	45170.03500.27	Old iron	Iron	35x35		Decorative corner	8
	45170.05500.27	Old iron	Iron	55x55		Decorative corner	8









Photo	Code	Finish description	Mat.	Measures mm		Description	Box Pcs
				Size	Ø / C to C		
	46005.07000.64	Tropicalized	Iron	70x15		Latch	25
	49011.02000.17	Polish brass effect	Iron	20		Hook	100
	49011.03500.17	Polish brass effect	Iron	35		Hook	100
	49011.04000.17	Polish brass effect	Iron	40		Hook	100
	49014.05700.33	Zinc plated	Iron	57x45		Hook	50
	49015.08600.33	Zinc plated	Iron	45x22		Hook	50
	49016.04700.33	Zinc plated	Iron	45x47		Hook	50
	49018.04500.27	Old iron	Iron	25x45		Iron hook	100
	49019.03500.27	Old iron	Iron	35x40		Iron hook	100
	49021.00400.17C	Polish brass effect	Brass	30x30		Corner for glasses	20
	49031.02000.32C	Bright nickel	Steel		20	Foot pad	50
	49031.02600.32C	Bright nickel	Steel		26	Foot pad	50





Photo	Code	Finish description	Mat.	Measures mm		Description	Box Pcs
				Size	Ø / C to C		
	49037.01700.04	Bronzed	Iron	17	17	Cap for nut	1000
	49037.01700.17	Polish brass effect	Iron	17	17	Cup for nut	1000
	49085Z05700.04	Bronzed	Zamak	57x57		Corner for glasses	20
	49086.40000.04C	Bronzed	Brass	400		Chain	25
	49087.20000.11	Polish brass	Brass	200		Chain	25
	49087.25000.11	Polish brass	Brass	250		Chain	25
	49087.30000.11	Polish brass	Brass	300		Chain	25
	49087.35000.11	Polish brass	Brass	350		Chain	25
	65039.01900.17	Polish brass effect	Iron	18,5	M10	Bush	100
	65039.02500.17	Polish brass effect	Iron	25	M10	Bush	100
	65039.03000.17	Polish brass effect	Iron	30	M10	Bush	100
	65057Z01500.00	Natural color	Zamak	15	M8	Bush	100
	65091.01000.40	Natural brass	Brass	7x8,5	M5	Bush for shelf support	1000





Photo	Code	Finish description	Mat.	Measures mm		Description	Box Pcs
				Size	Ø / C to C		
Screws							
	65006.03000.21	Raw iron	Iron	30x7		Iron screw TE	100
	65006.04000.21	Raw iron	Iron	40x7		Iron screw TE	100
	65006.05000.21	Raw iron	Iron	50x7		Iron screw TE	100
	65006.06000.21C	Raw iron	Iron	60x7		Iron screw TE	100
	65006.08000.21C	Raw iron	Iron	80x7		Iron screw TE	100
	65014.01000.21	Raw iron	Iron		M10	Nut	100
	65015.01000.04	Bronzed	Iron	2x10		Iron screw TT	1000
	65015.01000.17	Polish brass effect	Iron	2x10		Iron screw TT	1000
	65015.01200.04	Bronzed	Iron	2x12		Iron screw TT	1000
	65015.01200.17	Polish brass effect	Iron	2x12		Iron screw TT	1000
	65015.01200.32	Bright Nickel	Iron	2x12		Iron screw TT	1000
	65016.01600.04	Bronzed	Iron	2,5x16		Iron screw TT	1000
	65016.01600.17	Polish brass effect	Iron	2,5x16		Iron screw TT	1000
	65016.02000.04	Bronzed	Iron	2,5x20		Iron screw TT	1000
	65016.02000.17	Polish brass effect	Iron	2,5x20		Iron screw TT	1000
	65017.01600.04	Bronzed	Iron	3x16		Iron screw TT	1000
	65017.01600.17	Polish brass effect	Iron	3x16		Iron screw TT	1000
	65017.02000.04	Bronzed	Iron	3x20		Iron screw TT	1000
65017.02000.17	Polish brass effect	Iron	3x20		Iron screw TT	1000	
	65019.01200.04	Bronzed	Iron	2,5x12		Chipboard screw TP	1000
	65019.01200.17	Polish brass effect	Iron	2,5x12		Chipboard screw TP	1000
	65019.01500.04	Bronzed	Iron	2,5x15		Chipboard screw TP	1000
	65019.01500.17	Polish brass effect	Iron	2,5x15		Chipboard screw TP	1000
	65019.02000.17	Bronzed	Iron	2,5x20		Chipboard screw TP	1000
	65019.02500.17	Polish brass effect	Iron	2,5x25		Chipboard screw TP	1000
	65020.01200.04	Bronzed	Iron	3x12		Chipboard screw TP	1000
	65020.01200.17	Polish brass effect	Iron	3x12		Chipboard screw TP	1000
	65020.01500.04	Bronzed	Iron	3x15		Chipboard screw TP	1000

Photo	Code	Finish description	Mat.	Measures mm		Description	Box Pcs
				Size	Ø / C to C		
	65020.01500.17	Polish brass effect	Iron	3x15		Chipboard screw TP	1000
	65020.01800.04	Bronzed	Iron	3x18		Chipboard screw TP	1000
	65020.01800.17	Polish brass effect	Iron	3x18		Chipboard screw TP	1000
	65020.02000.04	Bronzed	Iron	3x20		Chipboard screw TP	1000
	65020.02000.17	Polish brass effect	Iron	3x20		Chipboard screw TP	1000
	65020.02500.04	Bronzed	Iron	3x25		Chipboard screw TP	1000
	65020.02500.17	Polish brass effect	Iron	3x25		Chipboard screw TP	1000
	65020.03000.04	Bronzed	Iron	3x30		Chipboard screw TP	1000
	65020.03000.17	Polish brass effect	Iron	3x30		Chipboard screw TP	1000
	65020.03500.04	Bronzed	Iron	3x35		Chipboard screw TP	1000
	65020.03500.17	Polish brass effect	Iron	3x35		Chipboard screw TP	1000
	65021.01500.04	Bronzed	Iron	3,5x15		Chipboard screw TP	1000
	65021.01800.04	Bronzed	Iron	3,5x18		Chipboard screw TP	1000
	65021.02000.04	Bronzed	Iron	3,5x20		Chipboard screw TP	1000
	65021.02500.04	Bronzed	Iron	3,5x25		Chipboard screw TP	1000
	65021.03000.04	Bronzed	Iron	3,5x30		Chipboard screw TP	1000
	65021.03500.04	Bronzed	Iron	3,5x35		Chipboard screw TP	1000
	65021.04000.04	Bronzed	Iron	3,5x40		Chipboard screw TP	1000
	65022.01800.04	Bronzed	Iron	4x18		Chipboard screw TP	1000
	65022.02000.04	Bronzed	Iron	4x20		Chipboard screw TP	1000
	65022.02500.04	Bronzed	Iron	4x25		Chipboard screw TP	1000
	65022.03000.04	Bronzed	Iron	4x30		Chipboard screw TP	1000
	65022.03500.04	Bronzed	Iron	4x35		Chipboard screw TP	1000
	65022.04000.04	Bronzed	Iron	4x40		Chipboard screw TP	500
	65022.04500.04	Bronzed	Iron	4x45		Chipboard screw TP	500
	65022.05000.04	Bronzed	Iron	4x50		Chipboard screw TP	500
	65022.06000.04	Bronzed	Iron	4x60		Chipboard screw TP	500
	65023.04000.04	Bronzed	Iron	4,5x40		Chipboard screw TP	500
	65023.05000.04	Bronzed	Iron	4,5x50		Chipboard screw TP	500
	65023.06000.04	Bronzed	Iron	4,5x60		Chipboard screw TP	200
65024.05000.04	Bronzed	Iron	5x50		Chipboard screw TP	500	
65024.06000.04	Bronzed	Iron	5x60		Chipboard screw TP	200	

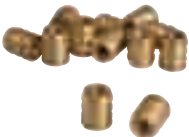
Photo	Code	Finish description	Mat.	Measures mm		Description	Box Pcs
				Size	Ø / C to C		
	65024.07000.04	Bronzed	Iron	5x70		Chipboard screw TP	200
	65024.08000.04	Bronzed	Iron	5x80		Chipboard screw TP	200
	65025.07000.04	Bronzed	Iron	6x70		Chipboard screw TP	200
	65027.04500.21	Raw iron	Iron	45x15		Bracket	100
	65028.00800.21	Raw iron	Iron		M8	4 prongs bottom	100
	65028.01000.21	Raw iron	Iron		M10	4 prongs bottom	100
	65030.02000.21	Raw iron	Iron	foro 10	20	Washer	100
	65030.03000.21	Raw iron	Iron	foro 10	30	Washer	100
	65032.01400.21	Raw iron	Iron	foro 6	14	Washer	100
	65309.01000.04	Bronzed	Iron	1,0x10		Iron nail - roundheaded	1kg.
	65309.01000.17	Polish brass effect	Iron	1,0x10		Iron nail - roundheaded	1kg.
	65309.01200.04	Bronzed	Iron	1,0x12		Iron nail - roundheaded	1kg.
	65309.01200.17	Polish brass effect	Iron	1,0x12		Iron nail - roundheaded	1kg.
	65309.01400.04	Bronzed	Iron	1,1x14		Iron nail - roundheaded	1kg.
	65309.01400.17	Polish brass effect	Iron	1,1x14		Iron nail - roundheaded	1kg.
	65309.01400.32	Bright chrome	Iron	1,1x14		Iron nail - roundheaded	1kg.
	65309.01600.04	Bronzed	Iron	1,2x16		Iron nail - roundheaded	1kg.
	65309.01600.17	Polish brass effect	Iron	1,2x16		Iron nail - roundheaded	1kg.
	65309.01800.04	Bronzed	Iron	1,2x18		Iron nail - roundheaded	1kg.
	65309.01800.17	Polish brass effect	Iron	1,2x18		Iron nail - roundheaded	1kg.
	65309.01800.32	Bright chrome	Iron	1,2x18		Iron nail - roundheaded	1kg.
	FESI4X20TB/200	Old iron	Iron	4x20		Roundhead screw with slot	200
	FESI4X25TB/200	Old iron	Iron	4x25		Roundhead screw with slot	200
	FESI4X30TB/200	Old iron	Iron	4x30		Roundhead screw with slot	200
	FESI5X20TB/200	Old iron	Iron	5x20		Roundhead screw with slot	200
	FESI5X25TB/200	Old iron	Iron	5x25		Roundhead screw with slot	200
	FESI5X30TB/200	Old iron	Iron	5x30		Roundhead screw with slot	200
	FESI5X35TB/200	Old iron	Iron	5x35		Roundhead screw with slot	200



Photo	Code	Finish description	Mat.	Measures mm		Description	Box Pcs
				Size	Ø / C to C		
	65321.01500.33	Zinc plated	Iron	15	M4	Dowel screw	500
	65321.02000.33	Zinc plated	Iron	20	M4	Dowel screw	500
	65322.01200.04	Bronzed	Iron	12	M4	Screw TBC	500
	65322.01400.04	Bronzed	Iron	14	M4	Screw TBC	500
	65322.01600.04	Bronzed	Iron	16	M4	Screw TBC	500
	65322.01800.04	Bronzed	Iron	18	M4	Screw TBC	500
	65322.02000.04	Bronzed	Iron	20	M4	Screw TBC	500
	65322.02200.04	Bronzed	Iron	22	M4	Screw TBC	500
	65322.02400.04	Bronzed	Iron	24	M4	Screw TBC	500
	65322.02600.04	Bronzed	Iron	26	M4	Screw TBC	500
	65322.02800.04	Bronzed	Iron	28	M4	Screw TBC	500
	65322.03000.04	Bronzed	Iron	30	M4	Screw TBC	500
	65322.03200.04	Bronzed	Iron	32	M4	Screw TBC	500
	65322.03400.04	Bronzed	Iron	34	M4	Screw TBC	500
	65322.03600.04	Bronzed	Iron	36	M4	Screw TBC	500
	65322.03800.04	Bronzed	Iron	38	M4	Screw TBC	500
	65322.04000.04	Bronzed	Iron	40	M4	Screw TBC	500
	65322.04200.04	Bronzed	Iron	42	M4	Screw TBC	500
	65322.04400.04	Bronzed	Iron	44	M4	Screw TBC	500
	65322.04600.04	Bronzed	Iron	46	M4	Screw TBC	500
	65322.04800.04	Bronzed	Iron	48	M4	Screw TBC	500
	65400.05000.64	Tropicalized	Iron	50	M4	Breakable screw	1000

Photo	Code	Finish description	Mat.	Measures mm		Description	Box Pcs
				Size	Ø / C to C		
	65049.06000.33	Zinc plated	Iron	60	M4	Thread screw	500
	65328.05000.21	Raw iron	Iron	50	M10	Rolled thread screw	200
	65328.06000.21	Raw iron	Iron	60	M10	Rolled thread screw	200
	65328.07000.21	Raw iron	Iron	70	M10	Rolled thread screw	200
	65328.08000.21	Raw iron	Iron	80	M10	Rolled thread screw	200
	65328.09000.21	Raw iron	Iron	90	M10	Rolled thread screw	200
	65328.10000.21	Raw iron	Iron	100	M10	Rolled thread screw	200
	65347.01500.17	Polish brass effect	Iron	15	M6	Screw TB	200
	65347.02000.17	Polish brass effect	Iron	20	M6	Screw TB	200
	65347.02500.17	Polish brass effect	Iron	25	M6	Screw TB	200
	65347.03000.17	Polish brass effect	Iron	30	M6	Screw TB	200

Photo	Code	Finish description	Mat.	Measures mm		Description	Box Pcs
				Size	Ø / C to C		
Various							
	31001.04000.00C	Natural color	Plastic	40		Wheel with steel plate and cover	24
	31002.04000.00C	Natural color	Plastic	40		Wheel with steel plate	50
	31003.04000.00C	Natural color	Plastic	40		Wheel with steel plate	24
	31003.05000.00C	Natural color	Plastic	50		Wheel with steel plate	24
	31003.06000.00C	Natural color	Plastic	60		Wheel with steel plate	24
	41003.30000.G1	Brown	Plastic	300x20x1		Joint	20
	41003.36000.G1	Brown	Plastic	360x20x1		Joint	20
	41003.50000.G1	Brown	Plastic	500x20x1		Joint	20
	42008.C1200.17	Polish brass effect	Iron	1200	18	Pipe for wardrobe	10
	42009.C1200.17	Polish brass effect	Iron	15x22x1200		Pipe for wardrobe	10
	42009.C2000.17	Polish brass effect	Iron	15x22x2000		Pipe for wardrobe	10
	42009.C2000.32C	Bright chrome	Iron	15x22x2000		Pipe for wardrobe	10
	42014Z01500.17	Polish brass effect	Zamak	60x18		Support for pipe	25
	42014Z01500.32C	Bright chrome	Zamak	60x18		Support for pipe	25
	42016Z01800.17C	Polish brass effect	Zamak	100x45		Support for pipe	25



Photo	Code	Finish description	Mat.	Measures mm		Description	Box Pcs
				Size	Ø / C to C		
	42019Z03000.17C	Polish brass effect	Zamak	110x45		Support for pipe	25
	49044.01600.00	Brown	Felt		16	Round adhesive felt foot pad	1700
	49044.01800.00	Brown	Felt		18	Round adhesive felt foot pad	1120
	49044.02000.00	Brown	Felt		20	Round adhesive felt foot pad	1200
	49044.02200.00	Brown	Felt		22	Round adhesive felt foot pad	880
	49044.02400.00	Brown	Felt		24	Round adhesive felt foot pad	800
	49044.02600.00	Brown	Felt		26	Round adhesive felt foot pad	720
	49044.02800.00	Brown	Felt		28	Round adhesive felt foot pad	540
	49045.02500.00	Brown	Felt	25x25		Square adhesive felt foot pad	800
	49045.03000.00	Brown	Felt	30x30		Square adhesive felt foot pad	480
	49052.01200.F1	White	Plastic	1200		Hang-up pole	10
	49052.01200.G1	Brown	Plastic	1200		Hang-up pole	10
	52003.C2250.P2	Gray	Iron and Plastic	2250		Straghtening rod	10
	52005.C3000.04	Bronzed	Aluminium	3000		Track	10
	52006.C3000.P1	Black	Plastic	3000		Track	10







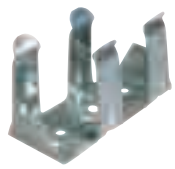

Photo	Code	Finish description	Mat.	Measures mm		Description	Box Pcs
				Size	Ø / C to C		
	52013.60000.21	Raw iron	Iron	500x20		Extension table	6
	52018.09000.21C	Natural color	Iron	900		Table leaf lift mechanism	1
	52022.00000.P1	Black	Plastic and Zamak	Portata 40 kg		Complete adjustable kit for leaf	1
	52029.00000.05	Black	Plastic and Zamak	Portata 50 kg		Complete adjustable kit for leaf	1
	52028.C3000.P1	Black	Plastic	3000		Brush	10
	53001.08000.33	Zinc plated	Steel	h.80	28	Metal foot	50
	53001.10000.33	Zinc plated	Steel	h.100	28	Metal foot	50
	53001.12000.33	Zinc plated	Steel	h.120	28	Metal foot	50
	53005.04600.33	Zinc plated	Steel	30x46		Skirting board hook with art. 53037 and 53038.05100.P1 (pag. 73)	50
	53036.05500.33	Zinc plated	Steel	28x55		Skirting board hook	50
	53036.07000.33	Zinc plated	Steel	28x70		Skirting board hook	50
	53037.10000.33	Zinc plated	Steel	h.100	28	Metal foot	50
	53037.12000.33	Zinc plated	Steel	h.120	28	Metal foot	50

Photo	Code	Finish description	Mat.	Measures mm		Description	Box Pcs
				Size	Ø / C to C		
	53038.05100.P1	Black	Plastic	51x37		Rabbet for art. 53005.04600.33	50
	53044.40000.DA	Gray	Cast iron	base d.400x h.730		Steel base available in different colors	1
	53045.45000.36	Bright chrome	Steel	base d.450x h.730		Steel base - available in different colors	1
	53046.40000.P1	Black	Cast iron	base 400x400xh.730		Steel base - available in different colors	1
	53048.07100.00C	Satin	Steel	base 60x60x h.710		Steel table leg - square Available in different colors	4
	53054.71000.F1C	White	Steel	d.60x h.710		Steel table leg - round	4
	53054.71000.P1C	Black	Steel	d.60x h.710		Steel table leg - round	4
	53054.71000.32C	Bright nickel	Steel	d.60x h.710		Steel table leg - round	4
	53054.71000.34C	Satin	Steel	d.60x h.710		Steel table leg - round	4



Handmade collection



Iron collection



Glass collection



Ceramic collection



Bone collection



Accessories

Furniture Handles

Handmade collection



















Photo	Code	Finish description	Mat.	Measures mm	Description	Box Pcs
Handmade collection						
	15010.21000.40C	Natural brass	Brass	210x70	Handle	1
	15023.05000.03C	Antique brass	Brass	50x35	Handle	1
	15023.09000.03C	Antique brass	Brass	90x65	Handle	1
	15034.21000.40C	Natural brass	Brass	210x80	Handle	1
 R  L	15035.140D0.40C	Natural brass	Brass	140x65	Handle R	1
	15035.140S0.40C	Natural brass	Brass	140x65	Handle L	1
	15039.22000.40C	Natural brass	Brass	220x90	Handle	1
	15040.14000.40C	Natural brass	Brass	140x50	Handle	1

Photo	Code	Finish description	Mat.	Measures mm	Description	Box Pcs
 R	15042.210D0.40	Natural brass	Brass	210x50	Handle R	1
	15042.210S0.40	Natural brass	Brass	210x50	Handle L	1
 L						
	15154.24000.40	Natural brass	Brass	240x75	Handle	1
	15154.19500.40	Natural brass	Brass	195x70	Handle	1
	24TN.002036.03C	Antique brass	Brass	36	Knobs	1
	24TN.002041.03C	Antique brass	Brass	41	Knobs	1
	24TN.001032.03C	Antique brass	Brass	32	Knobs	1
	24TN.001043.03C	Antique brass	Brass	43	Knobs	1
	30055.090V0.03	Antique brass	Brass	90x60	Escutcheon	1
	30100.060V0.40C	Natural brass	Brass	60x45	Escutcheon	1
	30101.040V0.40C	Natural brass	Brass	65x40	Escutcheon	1









Handmade collection

Photo	Code	Finish description	Mat.	Measures mm	Description	Box Pcs
	30102.075V0.40C	Natural brass	Brass	75x50	Escutcheon	1
	30103.090V0.40C	Natural brass	Brass	90x80	Escutcheon	1
	45022.14000.40	Natural brass	Brass	140x50	Tip	1
	45018.08500.03	Antique brass	Brass	85x35	Tip	1
	45254.29001.40	Natural brass	Brass	290x70	Tip	1

Photo	Code	Finish description	Mat.	Measures mm		Description	Box Pcs
				Size	Ø / C to C		
Iron collection							
	03047.11200.27	Old iron	Iron	140x49	112	Handle	25
	03047.08400.27	Old iron	Iron	110x40	84	Handle	25
	06013.05700.27	Old iron	Iron	146x87	57	Handle	2
	06015.10500.27	Old iron	Iron	105x55	4,55	Handle	25
	09003.03200.27	Old iron	Iron	32x34		Handle	25
	09003.04100.27	Old iron	Iron	41x44		Handle	25
	09004.04500.27	Old iron	Iron	45x43		Handle	25
	09004.06300.27	Old iron	Iron	63x52		Handle	25
	09004.06700.27	Old iron	Iron	67x51		Handle	25
	09005.03000.27	Old iron	Iron	30x30	30	Handle	25
	09005.04000.27	Old iron	Iron	40x40	40	Handle	25
	09012.02800.27	Old iron	Iron		28	Handle	50
	09012.03200.27	Old iron	Iron		32	Handle	50
	09012.04000.27	Old iron	Iron		40	Handle	50
	09012.05000.27	Old iron	Iron		50	Handle	50
	09999.03700.27	Old iron	Iron	37X42		Handle	25

Iron collection

Photo	Code	Finish description	Mat.	Measures mm		Description	Box Pcs
				Size	Ø / C to C		
	12013.04000.27	Old iron	Iron	40x55	40	Handle	25
	12013.06500.27	Old iron	Iron	65x85	65	Handle	25
	12014.06000.27	Old iron	Iron	60x50		Handle	50
	15005.08000.27	Old iron	Iron		80	Handle	25
	15005.10000.27	Old iron	Iron		100	Handle	25
	15005.12000.27	Old iron	Iron		120	Handle	25
	15028.07400.27	Old iron	Iron	80x28	74	Handle	25
	15028.08500.27	Old iron	Iron	95x28	85	Handle	25
	FE09050	Old iron	Iron	12 diam.	96	Handle	1
	21002.06500.27	Old iron	Iron	28x81		Pendant	25
	240R.001035.27	Old iron	Iron		35	Knob	25
	24012.02000.27	Old iron	Iron	20x20	20	Knob	50
	24012.02500.27	Old iron	Iron	25x25	25	Knob	50
	24012.03400.27	Old iron	Iron	34x34	34	Knob	25

Photo	Code	Finish description	Mat.	Measures mm		Description	Box Pcs
				Size	Ø / C to C		
	24017.02500.27	Old iron	Iron	25x24	25	Knob	50
	24017.03000.27	Old iron	Iron	30x30	30	Knob	50
	24017.03500.27	Old iron	Iron	35x35	35	Knob	25
	24018.02000.27	Old iron	Iron	20x21	20	Knob	50
	24018.02500.27	Old iron	Iron	25x26	25	Knob	50
	24018.03000.27	Old iron	Iron	30x30	30	Knob	50
	24018.03500.27	Old iron	Iron	35x36	35	Knob	25
	FE09082	Old iron	Iron		15	Knob	50
	FE09083	Old iron	Iron		22	Knob	25
	FE09051	Old iron	Iron		28	Knob	25
	FE09084	Old iron	Iron		33	Knob	25
	30027.04400.27	Old iron	Iron		44	Escutcheon	25
	30028.126V0.27	Old iron	Iron	33x126		Escutcheon	25
	30029.131V0.27	Old iron	Iron	32x131		Escutcheon	25
	30030.048V0.27	Old iron	Iron	28x48		Escutcheon	25
	30031.036V0.27	Old iron	Iron	36x36		Escutcheon	25
	30031.046V0.27	Old iron	Iron	45x46		Escutcheon	25

Iron collection

Photo	Code	Finish description	Mat.	Measures mm		Description	Box Pcs
				Size	Ø / C to C		
	30032.126V0.27	Old iron	Iron	33x126		Escutcheon	25
	30033.072V0.27	Old iron	Iron	33x72		Escutcheon	25
	30034.072V0.27	Old iron	Iron	33x72		Escutcheon	25
	30035.151V0.27	Old iron	Iron	28x151		Escutcheon	25
	30036.035V0.27	Old iron	Iron	32x35		Escutcheon	25
	30036.046V0.27	Old iron	Iron	40x46		Escutcheon	25
	30037.160V0.27	Old iron	Iron	28x160		Escutcheon	25
	33005.0480N.27	Old iron	Iron	25x78	48	Key	25
	33015.0380N.27	Old iron	Iron	35x77	38	Key	25

Photo	Code	Finish description	Mat.	Measures mm		Description	Box Pcs
				Size	Ø / C to C		
 Big hole	34001.0450R.27	Old iron	Iron	27x80	45	Key	25
 Big hole	34002.0540T.27	Old iron	Iron	29x90	54	Key	25
 Big hole	34003.0460T.27	Old iron	Iron	33x90	46	Key	25
 Big hole	34004.0450R.27	Old iron	Iron	29x85	45	Key	25
 Big hole	34006.0900R.27	Old iron	Iron	47x140	90	Key	10
 Big hole	34007.0850R.27	Old iron	Iron	46x138	85	Key	10
 Big hole	34008.0520T.27	Old iron	Iron	28x89	52	Key	25
 Big hole	34010.0350R.27	Old iron	Iron	29x75	35	Key	25

Iron collection

Photo	Code	Finish description	Mat.	Measures mm		Description	Box Pcs
				Size	Ø / C to C		
	36001.05000.27	Old iron	Iron	27x85	50	Key	25
	36001.05800.27	Old iron	Iron	30x96	58	Key	25
	36002.04600.27	Old iron	Iron	32x85	46	Key	25
	36009.08700.27	Old iron	Iron	33x128	87	Key	10
	36010.08300.27	Old iron	Iron	25x115	83	Key	25
	45170.03500.27	Old iron	Iron	35x35		Decorative corner	8
	45170.05500.27	Old iron	Iron	55x55		Decorative corner	8
	FE091301	Old iron	Iron	80X150		Hook	1
	FE091311	Old iron	Iron	80X120		Hook	1
	FE091312	Old iron	Iron	80X170		Hook	1

Photo	Code	Finish description	Mat.	Measures mm		Description	Box Pcs
				Size	Ø / C to C		
Glass collection							
	24EM.001030.CR	Crystal	Glass	30x16	30	Knob	12
	24EM.001040.CR	Crystal	Glass	40x25	40	Knob	12
	24EM.001055.CR	Crystal	Glass	55x25	55	Knob	6
	24EM.002025.CR	Crystal	Glass	25x21	25	Knob	12
	24EM.002035.CR	Crystal	Glass	35x26	35	Knob	12
	24EM.003020.AM	Amethyst	Glass	20x20		Knob	12
	24EM.003025.AM	Amethyst	Glass	25x25		Knob	12
	24EM.003030.AM	Amethyst	Glass	30x30		Knob	12
	24EM.003020.AQ	Acquamarine	Glass	20x20		Knob	12
	24EM.003025.AQ	Acquamarine	Glass	25x25		Knob	12
	24EM.003030.AQ	Acquamarine	Glass	30x30		Knob	12
	24EM.003020.CR	Crystal	Glass	20x20		Knob	12
	24EM.003025.CR	Crystal	Glass	25x25		Knob	12
	24EM.003030.CR	Crystal	Glass	30x30		Knob	12
	24EM.003020.NE	Black	Glass	20x20		Knob	12
	24EM.003025.NE	Black	Glass	25x25		Knob	12
	24EM.003030.NE	Black	Glass	30x30		Knob	12
	24EM.003020.PA	Pulegoso light blue	Glass	20x20		Knob	12
	24EM.003025.PA	Pulegoso light blue	Glass	25x25		Knob	12
	24EM.003030.PA	Pulegoso light blue	Glass	30x30		Knob	12
	24EM.003020.PB	Pulegoso blue	Glass	20x20		Knob	12
	24EM.003025.PB	Pulegoso blue	Glass	25x25		Knob	12
	24EM.003030.PB	Pulegoso blue	Glass	30x30		Knob	12

Glass collection

Photo	Code	Finish description	Mat.	Measures mm		Description	Box Pcs
				Size	Ø / C to C		
	24EM.003020.PT	Pulegoso crystal	Glass	20x20		Knob	12
	24EM.003025.PT	Pulegoso crystal	Glass	25x25		Knob	12
	24EM.003030.PT	Pulegoso crystal	Glass	30x30		Knob	12
	24EM.003020.PV	Pulegoso green	Glass	20x20		Knob	12
	24EM.003025.PV	Pulegoso green	Glass	25x25		Knob	12
	24EM.003030.PV	Pulegoso green	Glass	30x30		Knob	12
	24EM.003020.PL	Pulegoso lilac	Glass	20x20		Knob	12
	24EM.003025.PL	Pulegoso lilac	Glass	25x25		Knob	12
	24EM.003030.PL	Pulegoso lilac	Glass	30x30		Knob	12
	24EM.003020.RO	Pink	Glass	20x20		Knob	12
	24EM.003025.RO	Pink	Glass	25x25		Knob	12
	24EM.003030.RO	Pink	Glass	30x30		Knob	12
	24EM.003020.TP	Topaz	Glass	20x20		Knob	12
	24EM.003025.TP	Topaz	Glass	25x25		Knob	12
	24EM.003030.TP	Topaz	Glass	30x30		Knob	12
	24EM.004022.CR	Crystal	Glass	22x34	22	Knob	12
	24EM.004022.NE	Black	Glass	22x34	22	Knob	12
	24EM.004022.SA	White satin	Glass	22x34	22	Knob	12

Photo	Code	Finish description	Mat.	Measures mm		Description	Box Pcs
				Size	Ø / C to C		
	24EM.005032.CR	Crystal	Glass	32x20	32	Knob	12
	24EM.006030.AQ	Acquamare	Glass	34x25	34	Knob	12
	24EM.006030.BL	Blue	Glass	34x25	34	Knob	12
	24EM.006030.CR	Crystal	Glass	34x25	34	Knob	12
	24EM.006030.PG	Light yellow	Glass	34x25	34	Knob	12
	24EM.006030.RO	Pink	Glass	34x25	34	Knob	12
	24EM.006030.VE	Green	Glass	34x25	34	Knob	12
	24EM.007060.BI	Incamiciato white	Glass	60x30	60	Knob	6
	24EM.007095.BI	Incamiciato white	Glass	100x40	100	Knob	4

Glass collection

Photo	Code	Finish description	Mat.	Measures mm		Description	Box Pcs
				Size	Ø / C to C		
	24EM.007060.IA	Iridescent	Glass	60x30	60	Knob	6
	24EM.007095.IA	Iridescent	Glass	100x40	100	Knob	4
	24EM.007060.IM	Honey iridescent	Glass	60x30	60	Knob	6
	24EM.007095.IM	Honey iridescent	Glass	100x40	100	Knob	4
	24EM.007060.NI	Incarniato black	Glass	60x30	60	Knob	6
	24EM.007095.NI	Incarniato black	Glass	100x40	100	Knob	4
	24EM.008037.CO	Crystal and gold	Glass	37x30	37	Knob	12
	24EM.008045.CO	Crystal and gold	Glass	45x35	45	Knob	6
	24EM.008037.CR	Crystal	Glass	37x30	37	Knob	12
	24EM.008045.CR	Crystal	Glass	45x35	45	Knob	6
	24EM.008037.NO	Black and gold	Glass	37x30	37	Knob	12
	24EM.008045.NO	Black and gold	Glass	45x35	45	Knob	6
	24EM.008037.TO	Topaz and gold	Glass	37x30	37	Knob	12
	24EM.008045.TO	Topaz and gold	Glass	45x35	45	Knob	6
	24EM.009037.BI	White	Glass	37x30	37	Knob	12
	24EM.009045.BI	White	Glass	45x35	45	Knob	6

Photo	Code	Finish description	Mat.	Measures mm		Description	Box Pcs
				Size	Ø / C to C		
	24EM.009037.BO	White and gold	Glass	37x30	37	Knob	12
	24EM.009045.BO	White and gold	Glass	45x35	45	Knob	6
	24EM.009037.CA	Crystal and silver	Glass	37x30	37	Knob	12
	24EM.009045.CA	Crystal and silver	Glass	45x35	45	Knob	6
	24EM.009037.NA	Black and silver	Glass	37x30	37	Knob	12
	24EM.009045.NA	Black and silver	Glass	45x35	45	Knob	6
	24EM.009037.NE	Black	Glass	37x30	37	Knob	12
	24EM.009045.NE	Black	Glass	45x35	45	Knob	6
	24EM.010045.IA	Iridescent	Glass	45x30	45	Knob	6
	24EM.010070.IA	Iridescent	Glass	70x45	70	Knob	4
	24EM.010045.IM	Honey iridescent	Glass	45x30	45	Knob	6
	24EM.010070.IM	Honey iridescent	Glass	70x45	70	Knob	4
	24EM.011035.CO	Crystal and gold	Glass	35x50	35	Knob	12
	24EM.011050.CO	Crystal and gold	Glass	50x40	50	Knob	6
	24EM.011035.IA	Iridescent	Glass	35x50	35	Knob	12
	24EM.011050.IA	Iridescent	Glass	50x40	50	Knob	6

Glass collection

Photo	Code	Finish description	Mat.	Measures mm		Description	Box Pcs
				Size	Ø / C to C		
	24EM.012030.AV	Aventurina	Glass	32x34	32	Knob	12
	24EM.012040.AV	Aventurina	Glass	42x44	42	Knob	6
	24EM.013050.CO	Crystal and gold	Glass	50x40	50	Knob	6
	24EM.013065.CO	Crystal and gold	Glass	65x45	65	Knob	4
	24EM.013050.CR	Crystal	Glass	50x40	50	Knob	6
	24EM.013065.CR	Crystal	Glass	65x45	65	Knob	4
	24EM.014035.CR	Crystal	Glass	35x27	35	Knob	12
	24EM.014035.PA	Pulegoso amber	Glass	35x27	35	Knob	12
	24EM.014035.PN	Pulegoso black	Glass	35x27	35	Knob	12
	24EM.014035.PT	Pulegoso crystal	Glass	35x27	35	Knob	12
	24EM.017030.CO	Crystal and gold	Glass	30x43	30	Knob	12













Photo	Code	Finish description	Mat.	Measures mm		Description	Box Pcs
				Size	Ø / C to C		
	24EM.017030.TO	Topaz and gold	Glass	30x43	30	Knob	12
	24EM.021025.CR	Crystal	Glass	35x28	35	Knob	12
	24EM.021035.CR	Crystal	Glass	50x40	50	Knob	12
	24EM.022055.CR	Crystal	Glass	25x55	55	Knob	6
	24EM.022095.CR	Crystal	Glass	95x30	95	Knob	2
	24EM.022055.IA	Iridescent	Glass	25x55	55	Knob	6
	24EM.022095.IA	Iridescent	Glass	95x30	95	Knob	2
	24EM.022055.PA	Pulegoso light blue	Glass	25x55	55	Knob	6
	24EM.022095.PA	Pulegoso light blue	Glass	95x30	95	Knob	2
	24EM.022055.PL	Pulegoso lavender	Glass	25x55	55	Knob	6
	24EM.022095.PL	Pulegoso lavender	Glass	95x30	95	Knob	2
	24EM.022055.PN	Pulegoso black	Glass	25x55	55	Knob	6
	24EM.022095.PN	Pulegoso black	Glass	95x30	95	Knob	2
	24EM.022055.PT	Pulegoso crystal	Glass	25x55	55	Knob	6
	24EM.022095.PT	Pulegoso crystal	Glass	95x30	95	Knob	2

Photo	Code	Finish description	Mat.	Measures mm		Description	Box Pcs
				Size	Ø / C to C		
	24EM.023045.CR	Crystal chrome base	Glass	45x45	45	Couple knobs for shower doors	1 CP
	24EM.023045.CS	Satin chrome base	Glass	45x45	45	Couple knobs for shower doors	1 CP
	24EM.029045.CR	Crystal - gold plated base	Glass	45x45	45	Couple knobs for shower doors	1 CP
	24EM.029045.CS	Satin - gold plated base	Glass	45x45	45	Couple knobs for shower doors	1 CP
	24EM.030045.CR	Crystal - nickel satin base	Glass	45x45	45	Couple knobs for shower doors	1 CP
	24EM.030045.CS	Satin - nickel satin base	Glass	45x45	45	Couple knobs for shower doors	1 CP
	24EM.024040.CR	Crystal chrome base	Glass	55x40	40	Couple knobs for shower doors	1 CP
	24EM.024040.CS	Satin chrome base	Glass	55x40	40	Couple knobs for shower doors	1 CP
	24EM.031040.CR	Crystal - gold plated base	Glass	55x40	40	Couple knobs for shower doors	1 CP
	24EM.031040.CS	Satin - gold plated base	Glass	55x40	40	Couple knobs for shower doors	1 CP
	24EM.032040.CR	Crystal - nickel satin base	Glass	55x40	40	Couple knobs for shower doors	1 CP
	24EM.032040.CS	Satin - nickel satin base	Glass	55x40	40	Couple knobs for shower doors	1 CP
	24EM.025048.CR	Crystal chrome base	Glass	60x48	48	Couple knobs for shower doors	1 CP
	24EM.025048.CS	Satin chrome base	Glass	60x48	48	Couple knobs for shower doors	1 CP
	24EM.033048.CR	Crystal - gold plated base	Glass	60x48	48	Couple knobs for shower doors	1 CP
	24EM.033048.CS	Satin - gold plated base	Glass	60x48	48	Couple knobs for shower doors	1 CP
	24EM.034048.CR	Crystal - nickel satin base	Glass	60x48	48	Couple knobs for shower doors	1 CP
	24EM.034048.CS	Satin - nickel satin base	Glass	60x48	48	Couple knobs for shower doors	1 CP
	24EM.026040.CR	Crystal chrome base	Glass	50x40	40	Couple knobs for shower doors	1 CP
	24EM.027040.CR	Crystal - gold plated base	Glass	50x40	40	Couple knobs for shower doors	1 CP
	24EM.028040.CR	Crystal - nickel satin base	Glass	50x40	40	Couple knobs for shower doors	1 CP
	24EM.036040.CR	Crystal - with chrome base	Glass	40x40		Couple knobs for shower doors	1 CP
	24EM.036040.CS	Satin - with chrome base	Glass	40x40		Couple knobs for shower doors	1 CP
	24EM.036050.CR	Crystal - with chrome base	Glass	50x50		Couple knobs for shower doors	1 CP
	24EM.036050.CS	Satin - with chrome base	Glass	50x50		Couple knobs for shower doors	1 CP

Photo	Code	Finish description	Mat.	Measures mm		Description	Box Pcs	
				Size	Ø / C to C			
Ceramic collection								
	24CF.0145.10	Cream gold	Ceramic	45x28	45	Knob	6	
	24CF.0145.12	Silver leaf	Ceramic	45x28	45	Knob	6	
	24CF.0145.13	Mother of pearl	Ceramic	45x28	45	Knob	6	
	24CF.0145.14	White	Ceramic	45x28	45	Knob	6	
	24CF.0145.16	Bright red	Ceramic	45x28	45	Knob	6	
	24CF.0145.18	Craquelè	Ceramic	45x28	45	Knob	6	
	24CF.0145.19	Green gold	Ceramic	45x28	45	Knob	6	
	24CF.0145.20	Antique pink	Ceramic	45x28	45	Knob	6	
	24CF.0175.10	Cream gold	Ceramic	75x42	75	Knob	1	
	24CF.0175.12	Silver leaf	Ceramic	75x42	75	Knob	1	
	24CF.0175.13	Mother of pearl	Ceramic	75x42	75	Knob	1	
	24CF.0175.14	White	Ceramic	75x42	75	Knob	1	
	24CF.0175.16	Bright red	Ceramic	75x42	75	Knob	1	
	24CF.0175.18	Craquelè	Ceramic	75x42	75	Knob	1	
	24CF.0175.19	Green gold	Ceramic	75x42	75	Knob	1	
	24CF.0175.20	Antique pink	Ceramic	75x42	75	Knob	1	
		24CF.0245.10	Cream gold	Ceramic	45x28	45	Knob	6
		24CF.0245.12	Silver leaf	Ceramic	45x28	45	Knob	6
		24CF.0245.18	Craquelè	Ceramic	45x28	45	Knob	6
		24CF.0245.19	Green gold	Ceramic	45x28	45	Knob	6
24CF.0245.20		Antique pink	Ceramic	45x28	45	Knob	6	
24CF.0275.10		Cream gold	Ceramic	75x42	75	Knob	1	
24CF.0275.12		Silver leaf	Ceramic	75x42	75	Knob	1	
24CF.0275.18		Craquelè	Ceramic	75x42	75	Knob	1	
24CF.0275.19		Green gold	Ceramic	75x42	75	Knob	1	
24CF.0275.20		Antique pink	Ceramic	75x42	75	Knob	1	

Ceramic collection

Photo	Code	Finish description	Mat.	Measures mm		Description	Box Pcs
				Size	Ø / C to C		
	24CF.0345.11	Gold leaf	Ceramic	45x30	45	Knob	6
	24CF.0345.12	Silver leaf	Ceramic	45x30	45	Knob	6
	24CF.0345.18	Craquelè	Ceramic	45x30	45	Knob	6
	24CF.0345.19	Green gold	Ceramic	45x30	45	Knob	6
	24CF.0345.20	Antique pink	Ceramic	45x30	45	Knob	6
	24CF.0375.11	Gold leaf	Ceramic	75x42	75	Knob	1
	24CF.0375.12	Silver leaf	Ceramic	75x42	75	Knob	1
	24CF.0375.18	Craquelè	Ceramic	75x42	75	Knob	1
	24CF.0375.19	Green gold	Ceramic	75x42	75	Knob	1
	24CF.0375.20	Antique pink	Ceramic	75x42	75	Knob	1
	24CF.0445.11	Gold leaf	Ceramic	45x32	45	Knob	6
	24CF.0445.12	Silver leaf	Ceramic	45x32	45	Knob	6
	24CF.0445.18	Craquelè	Ceramic	45x32	45	Knob	6
	24CF.0445.19	Green gold	Ceramic	45x32	45	Knob	6
	24CF.0445.20	Antique pink	Ceramic	45x32	45	Knob	6
	24CF.0475.11	Gold leaf	Ceramic	75x42	75	Knob	1
	24CF.0475.12	Silver leaf	Ceramic	75x42	75	Knob	1
	24CF.0475.18	Craquelè	Ceramic	75x42	75	Knob	1
	24CF.0475.19	Green gold	Ceramic	75x42	75	Knob	1
	24CF.0475.20	Antique pink	Ceramic	75x42	75	Knob	1
	24CF.0545.16	Bright red	Ceramic	45x28	45	Knob	6
	24CF.0545.17	Black	Ceramic	45x28	45	Knob	6
	24CF.0545.18	Craquelè	Ceramic	45x28	45	Knob	6
	24CF.0545.19	Green gold	Ceramic	45x28	45	Knob	6
	24CF.0545.20	Antique pink	Ceramic	45x28	45	Knob	6
	24CF.0575.16	Bright red	Ceramic	75x40	75	Knob	1
	24CF.0575.17	Black	Ceramic	75x40	75	Knob	1
	24CF.0575.18	Craquelè	Ceramic	75x40	75	Knob	1
	24CF.0575.19	Green gold	Ceramic	75x40	75	Knob	1
	24CF.0575.20	Antique pink	Ceramic	75x40	75	Knob	1

Photo	Code	Finish description	Mat.	Measures mm		Description	Box Pcs
				Size	Ø / C to C		
	24CF.0645.11	Gold leaf	Ceramic	45x28	45	Knob	6
	24CF.0645.12	Silver leaf	Ceramic	45x28	45	Knob	6
	24CF.0645.18	Craquelè	Ceramic	45x28	45	Knob	6
	24CF.0645.19	Green gold	Ceramic	45x28	45	Knob	6
	24CF.0645.20	Antique pink	Ceramic	45x28	45	Knob	6
	24CF.0675.11	Gold leaf	Ceramic	75x42	75	Knob	1
	24CF.0675.12	Silver leaf	Ceramic	75x42	75	Knob	1
	24CF.0675.18	Craquelè	Ceramic	75x42	75	Knob	1
	24CF.0675.19	Green gold	Ceramic	75x42	75	Knob	1
	24CF.0675.20	Antique pink	Ceramic	75x42	75	Knob	1
	24CF.0845.11	Gold leaf	Ceramic	45x28	45	Knob	6
	24CF.0845.12	Silver leaf	Ceramic	45x28	45	Knob	6
	24CF.0845.18	Craquelè	Ceramic	45x28	45	Knob	6
	24CF.0845.19	Green gold	Ceramic	45x28	45	Knob	6
	24CF.0875.11	Gold leaf	Ceramic	75x42	75	Knob	1
	24CF.0875.12	Silver leaf	Ceramic	75x42	75	Knob	1
	24CF.0875.18	Craquelè	Ceramic	75x42	75	Knob	1
	24CF.0875.19	Green gold	Ceramic	75x42	75	Knob	1
	24CF.0945.11	Gold leaf	Ceramic	45x30	45	Knob	6
	24CF.0945.12	Silver leaf	Ceramic	45x30	45	Knob	6
	24CF.0945.18	Craquelè	Ceramic	45x30	45	Knob	6
	24CF.0945.19	Green gold	Ceramic	45x30	45	Knob	6
	24CF.0975.11	Gold leaf	Ceramic	75x42	75	Knob	1
	24CF.0975.12	Silver leaf	Ceramic	75x42	75	Knob	1
	24CF.0975.18	Craquelè	Ceramic	75x42	75	Knob	1
	24CF.0975.19	Green gold	Ceramic	75x42	75	Knob	1

Bone collection

Photo	Code	Finish description	Mat.	Measures mm		Description	Box Pcs
				Size	Ø / C to C		
Bone collection							
	24019.01000.00	Natural color	Bone	10x12	10	Knob	25
	24019.01200.00	Natural color	Bone	12x12	12	Knob	25
	24019.01500.00	Natural color	Bone	15x12	15	Knob	25
	24019.01800.00	Natural color	Bone	18x14	18	Knob	25
	24082.06000.00	Natural color	Bone	60x38	60	Knob with bar	4
	24082.08000.00	Natural color	Bone	80x44	80	Knob with bar	4
	24138.02000.00	Natural color	Bone	20x20		Knob with bush	12
	24138.03000.00	Natural color	Bone	30x25		Knob with bush	12
	24139.02000.00	Natural color	Bone	20x20		Knob with bush	12
	24139.03000.00	Natural color	Bone	30x25		Knob with bush	12
	24140.03000.00	Natural color	Bone	M4	30	Knob with bar	12
	24140.04000.00	Natural color	Bone	M4	40	Knob with bar	12
	24141.03000.00	Natural color	Bone	M4	30	Knob with bar	12
	24141.04000.00	Natural color	Bone	M4	40	Knob with bar	12
	24142.02200.00	Natural color	Bone	22x22	22	Knob with bush	12
	24142.02500.00	Natural color	Bone	25x30	25	Knob with bush	12
	30038.045V0.00	Natural color	Bone	32x45		Escutcheon	25



Photo	Code	Finish description	Mat.	Measures mm		Description	Box Pcs
				Size	Ø / C to C		
	30045.054V0.00	Natural color	Bone	27x54		Escutcheon	25
	30047.04900.00	Natural color	Bone	49x34		Escutcheon	25
	30049.046V0.00	Natural color	Bone	46x32		Escutcheon	25















Photo	Code	Finish description	Mat.	Measures mm		Description	Box Pcs
				Size	Ø / C to C		
Accessories							
	31004.02500.03	Antique brass	Brass	57x75	25	Tip with wheel	10
	31004.02700.03	Antique brass	Brass	57x78	27	Tip with wheel	10
	31005.04000.03	Antique brass	Brass	40x31		Fork with wheel	25
	31005.04900.03	Antique brass	Brass	49x39		Fork with wheel	25
	31006.02100.03	Antique brass	Brass	43x60	21	Tip with wheel	25
	31006.02100.66	Shining brass	Brass	43x60	21	Tip with wheel	25
	31006.03100.03	Antique brass	Brass	61x72	31	Tip with wheel	25
	31006.03100.66	Shining brass	Brass	61x72	31	Tip with wheel	25
	31008.04500.03	Antique brass	Brass	45x65		Fork with wheel	25
	31008.04500.66	Shining brass	Brass	45x65		Fork with wheel	25
	31008.05500.03	Antique brass	Brass	55x73		Fork with wheel	25
	31008.05500.66	Shining brass	Brass	55x73		Fork with wheel	25
	31011.10500.11	Polish brass	Brass	70x105	70	Wheel	10
	31011.13000.11	Polish brass	Brass	103x130	103	Wheel	10
	43013.03000.03	Antique brass	Brass	24x30		Hook	100
	43013.04000.03	Antique brass	Brass	30x40		Hook	100
	43030.08300.03	Antique brass	Brass	83x36		Hook	50

Photo	Code	Finish description	Mat.	Measures mm		Description	Box Pcs
				Size	Ø / C to C		
	55002.00500.66	Shining brass	Wood and brass	5x5x2000		Coated frame	1
	55002.00700.66	Shining brass	Wood and brass	4x7x2000		Coated frame	1
	55002.01100.66	Shining brass	Wood and brass	8x11x2000		Coated frame	1
	55003.00700.66	Shining brass	Wood and brass	4x7x2000		Coated frame	1
	55003.00800.66	Shining brass	Wood and brass	5x8x2000		Coated frame	1
	55003.01100.66	Shining brass	Wood and brass	8x11x2000		Coated frame	1
	55004.00700.66	Shining brass	Wood and brass	3x7x2000		Coated frame	1
	55004.00900.66	Shining brass	Wood and brass	4x9x2000		Coated frame	1
	55005.03500.66	Shining brass	Brass	35x10000		Frame	1
	55006.03000.66	Shining brass	Brass	30x10000		Frame	1
	55007.03000.66	Shining brass	Brass	30x10000		Frame	1
	55008.01800.66	Shining brass	Brass	18x10000		Frame	1
	55010.00300.66	Shining brass	Brass	3x100x1000		Frame	10
	55010.00500.66	Shining brass	Brass	5x100x1000		Frame	10

-  Straps
-  Locks
-  Latches
-  Nails
-  Various

Frame construction

Straps





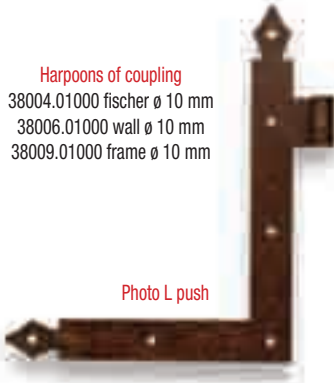

Photo	Code	Finish description	Mat.	Measures mm		Description	Box Pcs
				Size	Ø / C to C		
Straps							
 <p>Harpoons of coupling 38004.01200 fischer ø 12 mm 38006.01200 wall ø 12 mm 38009.01200 frame ø 12 mm</p>	38003.30000.27	Old iron	Iron	40x300	d. 12	Strap	1
	38003.40000.27	Old iron	Iron	40x400	d. 12	Strap	1
	38003.50000.27	Old iron	Iron	40x500	d. 12	Strap	1
	Technical drawing page 129						
	38004.01000.27	Old iron	Iron	h.80	d.10	Fischer hook	1
	38004.01200.27	Old iron	Iron	h.80	d.12	Fischer hook	1
	38004.01600.27	Old iron	Iron	h.80	d.16	Fischer hook	1
	Technical drawing page 129						
	38006.01000.27	Old iron	Iron	150x80	d.10	Wall hook R-L	1
	38006.01200.27	Old iron	Iron	150x80	d.12	Wall hook R-L	1
	38006.01600.27	Old iron	Iron	150x80	d.16	Wall hook R-L	1
	Technical drawing page 129						
 <p>Harpoons of coupling 38004.01200 fischer ø 12 mm 38006.01200 wall ø 12 mm 38009.01200 frame ø 12 mm</p>	38007.30000.27	Old iron	Iron	300x40	d. 12	Flat strap	1
	38007.40000.27	Old iron	Iron	400x40	d. 12	Flat strap	1
	Technical drawing page 129						
	Technical drawing page 129						
	38009.01000.27	Old iron	Iron	30x70	d.10	Frame hook	1
	38009.01200.27	Old iron	Iron	30x70	d.12	Frame hook	1
	38009.01600.27	Old iron	Iron	30x70	d.16	Frame hook	1
	Technical drawing page 129						

Photo	Code	Finish description	Mat.	Measures mm		Description	Box Pcs	
				Size	Ø / C to C			
 <p>Harpoons of coupling 38004.01000 fischer ø 10 mm 38006.01000 wall ø 10 mm 38009.01000 frame ø 10 mm</p> <p>Photo L push</p>	38010.252D0.27	Old iron	Iron	202x252x30	d. 10	Square R	1	
	38010.252S0.27	Old iron	Iron	202x252x30	d. 10	Square L	1	
Technical drawing page 129								
 <p>Harpoons of coupling 38004.01600 fischer ø 16 mm 38006.01600 wall ø 16 mm 38009.01600 frame ø 16 mm</p> <p>Photo L push</p>	38013.430D0.27	Old iron	Iron	330x430x30	d.16	Flat square for door R	1	
	38013.430S0.27	Old iron	Iron	330x430x30	d.16	Flat square for door L	1	
Technical drawing page 130								
 <p>Photo L to pull</p>	38017.280D0.27	Old iron	Iron	250x280x20		Overlapping square square side R	1	
	38017.280S0.27	Old iron	Iron	250x280x20		Overlapping square square side L	1	
Technical drawing page 130								
 <p>Harpoons of coupling 38004.01600 fischer ø 10 mm 38006.01600 wall ø 10 mm 38009.01600 frame ø 10 mm</p> <p>Photo L push</p>	38020.210D0.27	Old iron	Iron	30x300	d.10	Shutter T with neck R square side	1	
	38020.210S0.27	Old iron	Iron	30x300	d.10	Shutter T with neck L square side	1	
Technical drawing page 130								

Straps





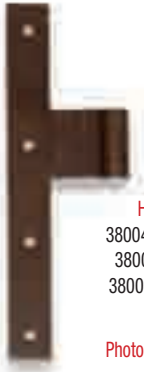











Photo	Code	Finish description	Mat.	Measures mm		Description	Box Pcs
				Size	Ø / C to C		
	38021.210D0.27	Old iron	Iron	25x210		Double T shutter with neck R	1
	38021.210S0.27	Old iron	Iron	25x210		Double T shutter with neck L	1
	Technical drawing page 130						
 <p>Harpoons of coupling 38004.01600 fischer ø 16 mm 38006.01600 wall ø 16 mm 38009.01600 frame ø 16 mm</p>	38022.300D0.27	Old iron	Iron	30x300	d.16	T plane support R	1
	38022.300S0.27	Old iron	Iron	30x300	d.16	T plane support L	1
	Technical drawing page 130						
 <p>Photo L to pull</p>	38023.180D0.27	Old iron	Iron	20x180		Shutter T with overlapping R	1
	38023.180S0.27	Old iron	Iron	20x180		Shutter T with overlapping L	1
	Technical drawing page 130						
 <p>Photo L to pull</p>	38024.180D0.27	Old iron	Iron	20X180		Shutter T with overlapping and forging wing R	1
	38024.180S0.27	Old iron	Iron	20X180		Shutter T with overlapping and forging wing L	1
	Technical drawing page 131						
 <p>Photo L to pull</p>	38025.180D0.27	Old iron	Iron	20X180		Shutter T with overlapping and moulded strap R	1
	38025.180S0.27	Old iron	Iron	20X180		Shutter T with overlapping and moulded strap L	1
	Technical drawing page 131						

Photo	Code	Finish description	Mat.	Measures mm		Description	Box Pcs	
				Size	Ø / C to C			
 <p>Harpoons of coupling 38004.01000 fischer ø 10 mm 38006.01000 wall ø 10 mm 38009.01000 frame ø 10 mm</p>	38026.200D0.27	Old iron	Iron	30x200	d.10	T flat band R	1	
	38026.200S0.27	Old iron	Iron	30x200	d.10	T flat band L	1	
	Technical drawing page 131							
	38027.18000.27	Old iron	Iron	90x180	d.10	Window Frame hinge	1	
	Technical drawing page 131							
	38044.20000.27	Old iron	Iron	30x70	d.10	Frame hook	1	
	Technical drawing page 131							
	39111.10000.64	Tropicalized	Iron	100x16		Closing (go and come)	2	
	39111.12000.64	Tropicalized	Iron	120x25		Closing (go and come)	2	
	48101.04400.26	Antique iron	Iron	13x44	d.13	Door hinge	25	
	48101.04800.26	Antique iron	Iron	14x48	d.14	Door hinge	25	
	48101.05200.26	Antique iron	Iron	16x52	d.16	Door hinge	25	
	48104.09000.26	Antique iron	Iron	13x90	d.13	Door hinge	25	
	48104.09400.26	Antique iron	Iron	14x94	d.14	Door hinge	25	
	48104.10400.26	Antique iron	Iron	16x104	d.15	Door hinge	25	

Straps

Photo	Code	Finish description	Mat.	Measures mm		Description	Box Pcs
				Size	Ø / C to C		
	FE09722	Old iron	Iron		d.11	Door hinge	25
	FE09723	Old iron	Iron		d.14	Door hinge	25
	FE09724	Old iron	Iron		d.16	Door hinge	25
	FE09730	Old iron	Iron		d.14	Cover hinge - smooth	20
	FE09731	Old iron	Iron		d.15	Cover hinge - smooth	20
	FE09732	Old iron	Iron		d.16	Cover hinge - smooth	20
	FE09733	Old iron	Iron		d.20	Cover hinge - smooth	20
	FE09734	Old iron	Iron		d.14	Cover hinge - baroque	20
	FE09735	Old iron	Iron		d.15	Cover hinge - baroque	20
	FE09736	Old iron	Iron		d.16	Cover hinge - baroque	20
	FE09737	Old iron	Iron		d.20	Cover hinge - baroque	20
	FE09236A	Old iron	Iron	200x30 h.45	d.14	Wall hook - pin	1
	FE09236B	Old iron	Iron	200x30 h.35	d.14	Wall hook - pin	1
Technical drawing page 131							
	FE09237A	Old iron	Iron	30x150 h.45	d.14	Frame hook	1
	FE09237B	Old iron	Iron	30x150 h.35	d.14	Frame hook	1
	FE09270	Old iron	Iron	30x205	d.12	Frame hook	1
	FE09238A	Old iron	Iron	h.45	d.14	Fischer hook	1
	FE09238B	Old iron	Iron	h.35	d.14	Fischer hook	1
	FE09271	Old iron	Iron	12x12x120	d.12	Fischer hook with side hole	1
Technical drawing page 132							
	FE09239A	Old iron	Iron	h.45	d.14	Fischer hook	1
	FE09239B	Old iron	Iron	h.35	d.14	Fischer hook	1
Technical drawing page 132							
	FE09240	Old iron	Iron	300x30	d.14	Strap	1
	FE09241	Old iron	Iron	400x30	d.14	Strap	1
Technical drawing page 132							
<p style="text-align: center;">Harpoons of coupling FE09236B - FE09237B - FE09238B - FE09239B</p>							

Photo	Code	Finish description	Mat.	Measures mm		Description	Box Pcs
				Size	Ø / C to C		
 Harpoons of coupling FE09236A - FE09237A - FE09238A - FE09239A	FE09242	Old iron	Iron	300x40	d.14	Strap	1
	FE09243	Old iron	Iron	400x40	d.14	Strap	1
	Technical drawing page 132						
 Harpoons of coupling FE09236A - FE09237A - FE09238A - FE09239A	FE09244	Old iron	Iron	300x35	d.14	Strap	1
	FE09245	Old iron	Iron	400x35	d.14	Strap	1
	Technical drawing page 132						
 Harpoons of coupling FE09236A - FE09237A - FE09238A - FE09239A	FE09246	Old iron	Iron	300x40	d.14	Strap	1
	FE09247	Old iron	Iron	400x40	d.14	Strap	1
	Technical drawing page 132						
	FE09215	Old iron	Iron	40X300Xh.22	d.14	Strap with frame hook	1
	FE09216	Old iron	Iron	40X300Xh.22	d.14	Strap with wall hook	1
	FE09217	Old iron	Iron	40X300Xh.22	d.14	Strap with fischer hook	1
	Technical drawing page 133						
	FE09250R	Old iron	Iron	300x300x40	d.14	Square for door R with frame hook	1
	FE09250L	Old iron	Iron	300x300x40	d.14	Square for door L with frame hook	1
	FE09251R	Old iron	Iron	300x300x40	d.14	Square for door R with wall hook	1
	FE09251L	Old iron	Iron	300x300x40	d.14	Square for door L with wall hook	1
	FE09252R	Old iron	Iron	300x300x40	d.14	Square for door R with fischer hook	1
	FE09252L	Old iron	Iron	300x300x40	d.14	Square for door L with fischer hook	1
Technical drawing page 133							
 Harpoons of coupling FE09270 frame ø 12 mm	FE09260	Old iron	Iron	300x40	d.12	Strap	1
	FE09261	Old iron	Iron	350x40	d.12	Strap	1
	FE09262	Old iron	Iron	400x40	d.12	Strap	1
	FE09263	Old iron	Iron	500x40	d.12	Strap	1
	Technical drawing page 133						

Straps

Photo	Code	Finish description	Mat.	Measures mm		Description	Box Pcs
				Size	Ø / C to C		
	FE09703	Old iron	Iron	70x135x20 h.17	d.8	Hinge with fframe hook	1
	Technical drawing page 133						
 Photo R	FE09704R	Old iron	Iron	90x135x20	d.8	Hinge R with frame hook	1
	FE09704L	Old iron	Iron	90x135x20	d.8	Hinge L with frame hook	1
	Technical drawing page 133						
	FE09705	Old iron	Iron	90x190x20 h.17	d.10	Window hinge with Frame hook	1
	Technical drawing page 133						
	FE09708R	Old iron	Iron	250x280x20		Square with frame hook and shutter hinge R	1
	FE09708L	Old iron	Iron	250x280x20		Square with frame hook and shutter hinge L	1
	Technical drawing page 134						
	FE09709	Old iron	Iron	65x70x40	d.8	Hinge with hook to push	1
	Technical drawing page 134						
	FE09709A	Old iron	Iron	65x70x40	d.8	Hinge with fischer hook	1
	Technical drawing page 134						
	FE09710	Old iron	Iron	20x135x105	d.8	Strap with hook to push	1
	Technical drawing page 134						

Photo	Code	Finish description	Mat.	Measures mm		Description	Box Pcs
				Size	Ø / C to C		
	FE09711R	Old iron	Iron	20x135x125	d.8	Strap with wood hook R	1
	FE09711L	Old iron	Iron	20x135x125	d.8	Strap with wood hook L	1
	Technical drawing page 134						
	FE09712	Old iron	Iron	100X20x40	d.8	Strap with hook to push	1
	Technical drawing page 134						
	Technical drawing page 135						
	FE09712A	Old iron	Iron	100X20x40	d.8	Strap with fischer hook	1
	Technical drawing page 135						
	Technical drawing page 135						
 <p>Photo L</p>	FE09715R	Old iron	Iron	130X90	d.8	Flat hinge R	1
	FE09715L	Old iron	Iron	130X90	d.8	Flat hinge L	1
	Technical drawing page 135						
 <p>Photo R</p>	FE09718R	Old iron	Iron	70x190 h.17	d.10	Strap "T" R with frame hook	1
	FE09718L	Old iron	Iron	70x190 h.17	d.10	Strap "T" L with frame hook	1
	Technical drawing page 135						
	FE09720R	Old iron	Iron	285x275 h.17	d.10	Strap "square" R with frame hook	1
	FE09720L	Old iron	Iron	285x275 h.17	d.10	Strap "square" L with frame hook	1
	Technical drawing page 135						
 <p>Harpoons of coupling FE042902</p>	FE42201	Old iron	Iron	300x40 h.22	d.12	Wire strap	1
	FE42202	Old iron	Iron	350X40 h.22.	d.12	Wire strap	1
	FE42203	Old iron	Iron	400x40 h.22.	d.12	Wire strap	1
	FE42204	Old iron	Iron	500x40 h.22	d.12	Wire strap	1
	Technical drawing page 135						
	FE42902	Old iron	Iron	30x205	d.12	Frame hook	1
	Technical drawing page 135						
	Technical drawing page 135						

Straps



Photo	Code	Finish description	Mat.	Measures mm		Description	Box Pcs	
				Size	Ø / C to C			
 <p>Harpoons of coupling FE042902</p>	FE40502R	Old iron	Iron	240x290x30 h.22	d.12	Wire square R	1	
	FE40502L	Old iron	Iron	240x290x30 h.22	d.12	Wire square L	1	
	Technical drawing page 136							
 <p>Harpoons of coupling FE042902</p>	FE40903R	Old iron	Iron	30x205 h.22	d.12	Strap "T" wire R	1	
	FE40903L	Old iron	Iron	30x205 h.22	d.12	Strap "T" wire L	1	
	Technical drawing page 136							



Photo	Code	Finish description	Mat.	Measures mm		Description	Box Pcs	
				Size	Ø / C to C			
Locks								
	50008.C190D.27	Old iron	Iron	2500		Closing shutter R	1	
	50008.C190S.27	Old iron	Iron	2500		Closing shutter L	1	
Technical drawing page 136								
	50029.11000.27	Old iron	Iron	110		Quick installation closing	1	
Technical drawing page 136								
	50030.C1600.27	Old iron	Iron	1600		Iron pole for closing quick installation	1	
	50030.C2000.27	Old iron	Iron	2000		Iron pole for closing quick installation	1	

Photo	Code	Finish description	Mat.	Measures mm		Description	Box Pcs
				Size	Ø / C to C		
	50033.C190D.27	Old iron	Iron	2500		Closing window R	1
	50033.C190S.27	Old iron	Iron	2500		Closing window L	1
Technical drawing page 136							
	50011.045D0.27	Old iron	Iron		45	Iron lock R	4
	50011.045S0.27	Old iron	Iron		45	Iron lock L	4
	50011.065D0.27	Old iron	Iron		65	Iron lock R	4
	50011.065S0.27	Old iron	Iron		65	Iron lock L	4
	50011.095D0.27C	Old iron	Iron		95	Iron lock R	4
	50011.095S0.27C	Old iron	Iron		95	Iron lock L	4
	50014.035D0.27	Old iron	Iron	35 Q8		Lock R	2
	50014.035S0.27	Old iron	Iron	35 Q8		Lock L	2
	50014.045D0.27	Old iron	Iron	45 Q8		Lock R	2
	50014.045S0.27	Old iron	Iron	45 Q8		Lock L	2
	50014.055D0.27	Old iron	Iron	55 Q8		Lock R	2
	50014.055S0.27	Old iron	Iron	55 Q8		Lock L	2
	50015.070D0.27	Old iron	Iron	70 Q8		Lock R	2
	50015.070S0.27	Old iron	Iron	70 Q8		Lock L	2
	50017.03500.27	Old iron	Iron	35 Q8		Lock R-L	2

Photo	Code	Finish description	Mat.	Measures mm		Description	Box Pcs
				Size	Ø / C to C		
	50019.04000.04C	Bronzed	Iron	40		Mortise lock - door	10
	50019.04500.04C	Bronzed	Iron	45		Mortise lock - door	10
	50019.05000.04C	Bronzed	Iron	50		Mortise lock - door	10
	50020.23800.04C	Bronzed	Iron	238x22		Joint for closing	10
	50035.12000.03	Antique brass	ottone	120x60		Closing window	2
	50035.12000.11	Bright brass	ottone	120x60		Closing window	2
	50036.06000.03	Antique brass	ottone	60x60		Flat latch	5
	50036.06000.11	Bright brass	ottone	60x60		Flat latch	5
	50036.06001.03	Antique brass	Ottone	60x60		Rabbit closing system	5
	50037.06000.03	Antique brass	Ottone	60x60		Brass closing system - wire	5
	44004.03500.27	Old iron	Iron	35x16		Shutter stop	25
	44005.22000.27	Old iron	Iron	220x25		Shutter stop	6







Photo	Code	Finish description	Mat.	Measures mm		Description	Box Pcs
				Size	Ø / C to C		
	44007.24500.27	Old iron	Iron	245		Puncheon with plate	6
	49204100001	Natural brass	ottone	60x40		Closing with joint	10
	49206500001	Natural brass	ottone	40x10		Joint for plier stop door	10
	49206000001	Natural brass	ottone	60x10		Plier stop door	10
	49210020001	Natural brass	ottone	45x10		Closing with joint	10
	50003.08100.27	Old iron	Iron	81		Closing	12
	FE09901	Old iron	Iron	1600		Complete closing "Torchetto" for window	1
	FE09904R	Old iron	Iron	1600		Complete closing "Torchetto" for window - 1 shutter R	1
	FE09904L	Old iron	Iron	1600		Complete closing "Torchetto" for window - 1 shutter L	1





Photo	Code	Finish description	Mat.	Measures mm		Description	Box Pcs
				Size	Ø / C to C		
	FE09905	Old iron	Iron	53x20	foro d. 10	Joint for espagnolette 1 shutter	1
	FE09902	Old iron	Iron	1400		Espagnolette	1
	FE09903	Old iron	Iron	2400		Espagnolette	1
	FE09804	Old iron	Iron	65X65		Door stop	1
	FE09805	Old iron	Iron	120X65		Door stop	1
	FE09550	Old iron	Iron	16X500	d.16	Bar for door - wall hinge	1
	FE09551	Old iron	Iron	18X650	d.18	Bar for door - wall hinge	1
	FE091009R	Old iron	Iron	600	d. 12,5	Forged iron R for table	1
	FE091009L	Old iron	Iron	600	d. 12,5	Forged iron L for table	1
	FE09101	Old iron	Iron	220x25		Latch	1
	FE09104	Old iron	Iron	130x25		Latch	1
	FE09102	Old iron	Iron	230		Latch	1











Photo	Code	Finish description	Mat.	Measures mm		Description	Box Pcs
				Size	Ø / C to C		
	FE09105	Old iron	Iron	20x62		Joint for latch - 2 shutter	5
	FE09716	Old iron	Iron	140x25x55		Shutter stop with screw	5
	FE09726	Old iron	Iron	80x25x105		Forged shutter stop with screw	5
	FE09727	Old iron	Iron	100x95		Registrable shutter stop	5

Photo	Code	Finish description	Mat.	Measures mm		Description	Box Pcs
				Size	Ø / C to C		
Latches							
	47001.08000.27	Old iron	Iron	80x60		Latch for shutter	10
	47002.18000.27	Old iron	Iron	50x180		Through straight latch	1
	47003.15000.27	Old iron	Iron	35x150		External latch	1
	47003.20000.27	Old iron	Iron	35x200		External latch	1
	47003.30000.27	Old iron	Iron	35x300		External latch	1
	47003.40000.27	Old iron	Iron	35x400		External latch	1
	47003.50000.27	Old iron	Iron	35x500		External latch	1
	47004.30000.27	Old iron	Iron	55x300		External latch	1
	47004.40000.27	Old iron	Iron	55x400		External latch	1
	47004.50000.27	Old iron	Iron	55x500		External latch	1
	47004.60000.27	Old iron	Iron	55x600		External latch	1
	47004.80000.27	Old iron	Iron	55x800		External latch	1
	47005.20000.27	Old iron	Iron	55x200		External latch - horizontal	1
	47005.30000.27	Old iron	Iron	55x300		External latch - horizontal	1
	47006.50000.27	Old iron	Iron	70x500		External latch - horizontal	1
	47007.20000.27	Old iron	Iron	35x200		Underplate latch	1
	47007.30000.27	Old iron	Iron	35x300		Underplate latch	1
	47007.40000.27	Old iron	Iron	35x400		Underplate latch	1





Latches

Photo	Code	Finish description	Mat.	Measures mm		Description	Box Pcs
				Size	Ø / C to C		
	47011.18000.27	Old iron	Iron	50x180		Fold through - latch	1
	47012.30000.27	Old iron	Iron	55x300		Fold vertical external latch	1
	47012.40000.27	Old iron	Iron	55x400		Fold vertical external latch	1
	47012.50000.27	Old iron	Iron	55x500		Fold vertical external latch	1
	47029.50000.27	Old iron	Iron	16x500	d.16	Forged latch with stop	1
	47032.30000.27	Old iron	Iron	14X300	d.14	Forged latch	1
	47032.40000.27	Old iron	Iron	14X400	d.14	Forged latch	1
	47033.04800.27	Old iron	Iron	48x60		Latch	10
	44003.02900.27	Old iron	Iron	12x26x29		Latch joint	12
	44009.03500.27	Old iron	Iron	35x25x10		Latch joint	6
	44018.02000.27	Old iron	Iron	20x85		Arc joint	10
	44018.02500.27	Old iron	Iron	25x85		Arc joint	10

Photo	Code	Finish description	Mat.	Measures mm		Description	Box Pcs
				Size	Ø / C to C		
	44092.06000.27	Old iron	Iron	60x25		Joint for latch	25
	FE09301	Old iron	Iron	250x130	d.14	Latch	1
	FE09306	Old iron	Iron	450x200	d.18	Latch	1
	FE09303	Old iron	Iron	300x45		Latch	1
	FE09304	Old iron	Iron	400x45		Latch	1
	FE09307	Old iron	Iron	370x70x200		Latch	1
	FE09308	Old iron	Iron	260x45		Latch	1
	FE09309	Old iron	Iron	80x150		Latch	1
	FE09310	Old iron	Iron	75x100		Latch	1
	FE09401	Old iron	Iron	170x45		Latch	1

Latches









Photo	Code	Finish description	Mat.	Measures mm		Description	Box Pcs
				Size	Ø / C to C		
	FE09402	Old iron	Iron	250x45		Latch	1
	FE09403	Old iron	Iron	35x150		Latch	1
	FE09404	Old iron	Iron	35x200		Latch	1
	FE09405	Old iron	Iron	35x300		Latch	1
	FE09406	Old iron	Iron	35x400		Latch	1
	FE09413	Old iron	Iron	15x15x65		Joint	10
	FE09407	Old iron	Iron	300x50	d.8	Latch	1
	FE09408	Old iron	Iron	400x50	d.8	Latch	1
	FE09409	Old iron	Iron	300x45		Vertical latch	1
	FE09410	Old iron	Iron	400x45		Vertical latch	1
	FE09801	Old iron	Iron	95x75		Shutter stop	1
	FE09802	Old iron	Iron	80x50		Latch	10
	FE09803	Old iron	Iron	75x74		Latch	10

Photo	Code	Finish description	Mat.	Measures mm		Description	Box Pcs
				Size	Ø / C to C		
Nails							
	65002.02000.03	Antique brass	Iron	20x22	d. 20	Iron boss	100
	65002.02000.05	Bronzed	Iron	20x22	d. 20	Iron boss	100
	65002.02000.27	Old iron	Iron	20x22	d. 20	Iron boss	100
	65002.02800.03	Antique brass	Iron	28x22	d. 28	Iron boss	100
	65002.02800.05	Bronzed	Iron	28x22	d. 28	Iron boss	100
	65002.02800.27	Old iron	Iron	28x22	d. 28	Iron boss	100
	65004.01100.26	Antique iron	Iron	6x11	d.6	Rustic nail Box Gr. 100 pc 360	5
	65004.01600.26	Antique iron	Iron	7x17	d.7	Rustic nail Box. Gr. 100 pc 220	5
	65029.02000.26	Antique iron	Iron	20	d.20,5	Iron nail	50 pz
	65029.03000.26	Antique iron	Iron	30	d.20,5	Iron nail	50 pz
	65029.04000.26	Antique iron	Iron	40	d.20,5	Iron nail	50 pz
	65029.05000.26	Antique iron	Iron	50	d.20,5	Iron nail	50 pz
	65029.06000.26	Antique iron	Iron	60	d.20,5	Iron nail	50 pz
	65029.07000.26	Antique iron	Iron	70	d.20,5	Iron nail	50 pz
	65029.08000.26	Antique iron	Iron	80	d.20,5	Iron nail	50 pz
	65037.02000.26	Antique iron	Iron	20	d.8	Iron nails about 950 pc. box	kg. 1
	65037.02500.26	Antique iron	Iron	25	d.8	Iron nails about 800 pc. box	kg. 1
	65037.03000.26	Antique iron	Iron	30	d.8	Iron nails about 750 pc. box	kg. 1
	65037.03500.26	Antique iron	Iron	35	d.10	Iron nails about 500 pc. box	kg. 1
	65037.04000.26	Antique iron	Iron	40	d.10	Iron nails about 360 pc. box	kg. 1
	65037.05000.26	Antique iron	Iron	50	d.11	Iron nails about 300 pc. box	kg. 1
	65037.06000.26	Antique iron	Iron	60	d.11	Iron nails about 210 pc. box	kg. 1
	65037.07000.26	Antique iron	Iron	70	d.12,5	Iron nails about 150 pc. box	kg. 1
	65037.08000.26	Antique iron	Iron	80	d.12,5	Iron nails about 120 pc. box	kg. 1
	65037.09000.26	Antique iron	Iron	90	d.13,5	Iron nails about 110 pc. box	kg. 1
	65037.10000.26	Antique iron	Iron	100	d.16	Iron nails about 100 pc. box	kg. 1
	65037.12000.26	Antique iron	Iron	120	d.16	Iron nails about 60 pc. box	kg. 1

Nails



Photo	Code	Finish description	Mat.	Measures mm		Description	Box Pcs
				Size	Ø / C to C		
	65070.02200.27	Old iron	Iron	25X28	d. 25	Forged nail	50
	65070.07500.27	Old iron	Iron	24x75	24	Forged nail	50
	65070.07501.27	Old iron	Iron	30X75	30	Forged nail	50
						Forged nail	
	65077.10500.27	Old iron	Iron	60x105	60	Forged nail	10
	65078.17000.27	Old iron	Iron	120x120x160		Plate with forged nail	10
	65079.17500.27	Old iron	Iron	95x95x175		Plate with forged nail	10
	65080.14000.27	Old iron	Iron	50x140		Forged nail	10
	65081.14500.27	Old iron	Iron	100x83x145		Plate with forged nail	10

Forged nails: these are hand-made nails, the measures may vary slightly.









Photo	Code	Finish description	Mat.	Measures mm		Description	Box Pcs
				Size	Ø / C to C		
	65082.16000.27	Old iron	Iron	80x80x160		Plate with forged nail	10
	65083.14500.27	Old iron	Iron	110x110x145		Plate with forged nail	10
	65084.03000.27	Old iron	Iron	28x30	d. 28	Forged nail	50
	65085.02200.27	Old iron	Iron	15x15	d. 15	Forged nail	50
	65086.03000.27	Old iron	Iron	30x37	d. 30	Forged nail	50
	65087.04200.27	Old iron	Iron	36x50	d. 30	Forged nail	50
	65093Z02200.22	Old america	Zamak	22x22x27		Printed nail	50
	65093Z02700.22	Old america	Zamak	25x25x29		Printed nail	50
	65093Z03200.22	Old america	Zamak	30x30x33		Printed nail	50
	65094Z02800.22	Old america	Zamak	26x28	d.26	Printed nail	50
	65094Z03600.22	Old america	Zamak	36x30	d.36	Printed nail	50

Forged nails: these are hand-made nails, the measures may vary slightly.

Nails

Photo	Code	Finish description	Mat.	Measures mm		Description	Box Pcs
				Size	Ø / C to C		
	65095Z03500.22	Old america	Zamak	35x35		Square nail	50
	65095Z04500.22	Old america	Zamak	45x45		Square nail	50
	65096.17000.27	Old iron	Iron	20x170		Forged nail	25
	65097.14500.27	Old iron	Iron	20x145		Forged nail	25
	65098.16000.27	Old iron	Iron	15x160		Forged nail	25
	65099.14500.27	Old iron	Iron	20x145		Forged nail	25
	65103.02600.C2	Copper	Copper	21x27	d. 21	Copper nail	50
	65104.03000.C2	Copper	Copper	23x26	d. 23	Copper nail	50
 <p>Square head</p>	65111.04000.26	Antique iron	Iron	12x40	d. 3,5	Iron nail - crushed head	1kg.
	65111.06000.26	Antique iron	Iron	12x60	d. 3,5	Iron nail - crushed head	1kg.
	65111.08000.26	Antique iron	Iron	12x80	d. 3,5	Iron nail - crushed head	1kg.

Forged nails: these are hand-made nails, the measures may vary slightly.

Photo	Code	Finish description	Mat.	Measures mm		Description	Box Pcs
				Size	Ø / C to C		
	65121.07500.27	Old iron	Iron	30x75	d. 30	Forged nail	50
	65122.08500.27	Old iron	Iron	15x85	15	Forged nail	50
	65123.07000.27	Old iron	Iron	30x70	d.30	Forged nail	50
	65124.07500.27	Old iron	Iron	60x75	d.60	Printed nail	50
	65125.07500.27	Old iron	Iron	40x75	d.40	Printed nail	50
	65126.08000.27	Old iron	Iron	30x80	30	Printed nail	50
	65126.08500.27	Old iron	Iron	40x85	40	Printed nail	50
	65126.09000.27	Old iron	Iron	55x90	55	Printed nail	50
	65127.08000.27	Old iron	Iron	32x32x80		Printed nail	50
	65128.07500.27	Old iron	Iron	32x32x75		Printed nail	50

Forged nails: these are hand-made nails, the measures may vary slightly.

Nails

Photo	Code	Finish description	Mat.	Measures mm		Description	Box Pcs
				Size	Ø / C to C		
	65130.08000.27	Old iron	Iron	30x80		Printed nail	50
	65131.07000.27	Old iron	Iron	15x75	d. 15	Forged nail	50
	65132.07500.27	Old iron	Iron	20x20x75		Forged nail	50
	65138.08000.27	Old iron	Iron	23x80	d. 23	Forged nail	50
	65139.08000.27	Old iron	Iron	20x20x80		Forged nail	50
	65140.08000.27	Old iron	Iron	22x22x80		Forged nail	50
	65141.08000.27	Old iron	Iron	25x25x80		Forged nail	50
	65142.08000.27	Old iron	Iron	30x12x80		Forged nail	50

Forged nails: these are hand-made nails, the measures may vary slightly.



Photo	Code	Finish description	Mat.	Measures mm		Description	Box Pcs
				Size	Ø / C to C		
	65143.08000.21	Ferro grezzo	Iron	103x36		Printed nail	10
	65145.03000.21	Ferro grezzo	Iron	28x21x36		Forged nail - not centered	50
	65145.03000.27	Old iron	Iron	28x21x36		Forged nail - not centered	50
	FE091132	Old iron	Iron	15x23	d. 15	Iron boss	50
	FE091130	Old iron	Iron	20x28	d. 20	Iron boss	50
	FE091131	Old iron	Iron	25x29	d. 25	Iron boss	50

Photo	Code	Finish description	Mat.	Measures mm		Description	Box Pcs
				Size	Ø / C to C		
Various							
	44021.00700.33	Zinc plated	Iron	Q 7		Movement Gratz with holes	6
	44022.00700.33	Zinc plated	Iron	Q 7		Movement Gratz with brushes	6
	44023.00700.33	Zinc plated	Iron	Q 7		Movement Gratz with pins	6
	44025.02200.00	Black	Iron	Q 8/7		Reduction 8 to 7	50
	44028.06200.33	Zinc plated	Iron	Q 8/7		Movement DK - Iron	6
	44135.01600.03	Antique brass	Ottone	16x25	d. 16	Door stop	10
	44135.01600.11	Bright brass	Ottone	16x25	d. 16	Door stop	10
	44135.01900.03	Antique brass	Ottone	18x30	d. 18	Door stop	10
	44135.01900.11	Bright brass	Ottone	18x30	d. 18	Door stop	10
	FE091303	Old iron	Iron	150x150		Shelf support	2
	FE091304	Old iron	Iron	200x200		Shelf support	2
	FE091305	Old iron	Iron	250x250		Shelf support	2



38003.30000.27

Page 102

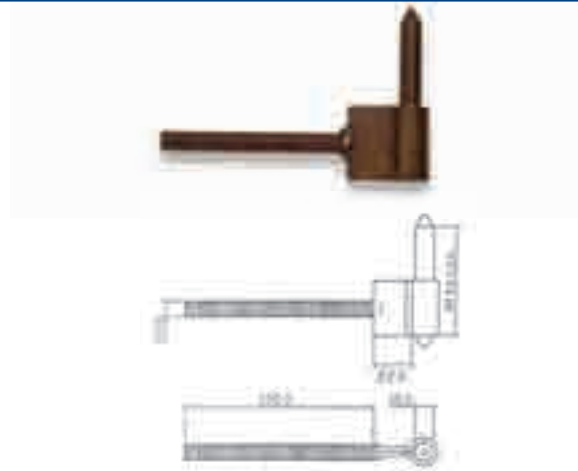
38004.01000.27

Page 102



38006.01000.27

Page 102

38007.30000.27

Page 102

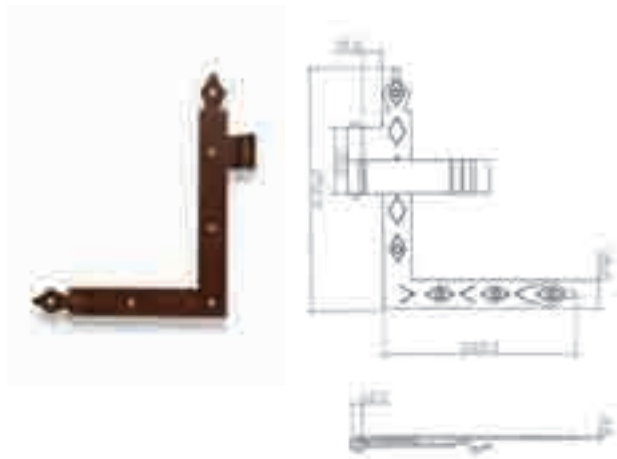





38009.01000.27

Page 102

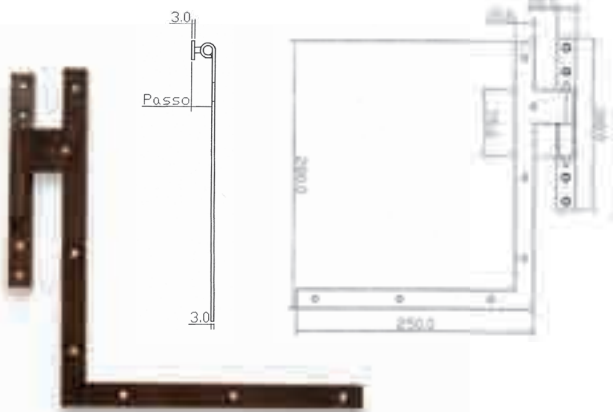
38010.252D0.27

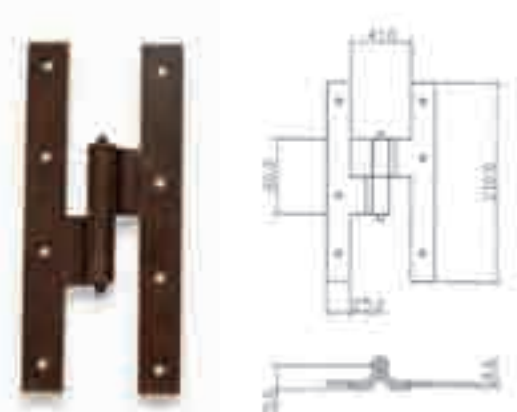
Page 103

			
<p>38013.430D0.27</p>	<p>Page 103</p>	<p>38017.280D0.27</p>	<p>Page 104</p>
			
<p>38020.210D0.27</p>	<p>Page 104</p>	<p>38021.210D0.27</p>	<p>Page 104</p>
			
<p>38022.300D0.27</p>	<p>Page 104</p>	<p>38023.180D0.27</p>	<p>Page 104</p>

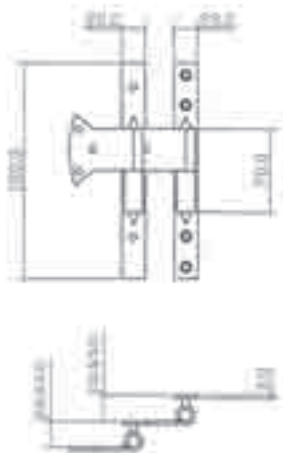

38024.180D0.27

Page 105

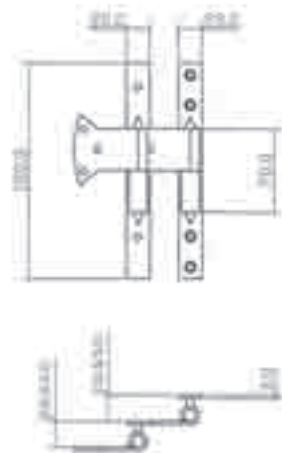

38025.180D0.27

Page 105

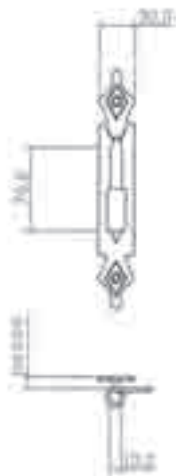

38026.200D0.27

Page 105



38027.18000.27

Page 105

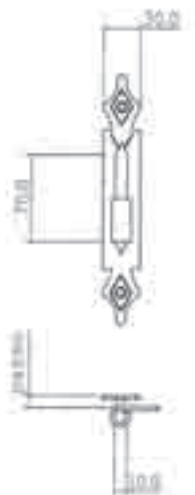

38044.20000.27

Page 105

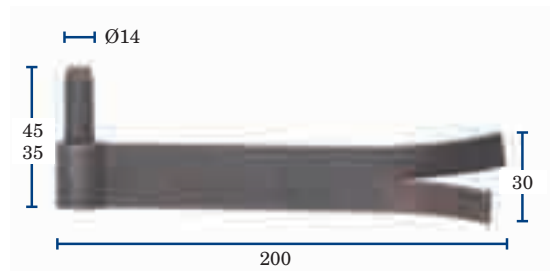

FE09236A

Page 106

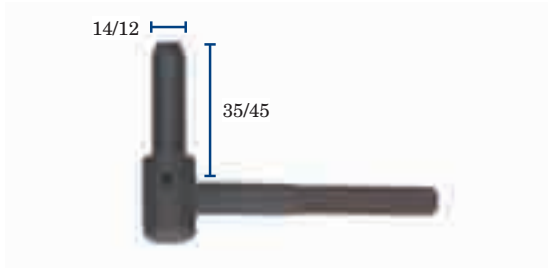

FE09238A

Page 107

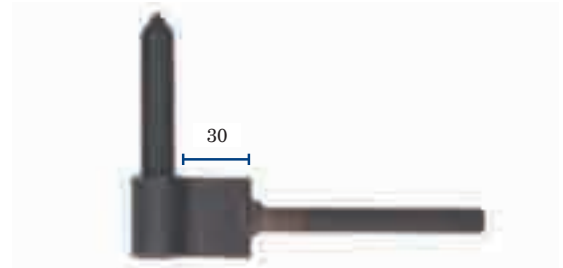

FE09239A

Page 107

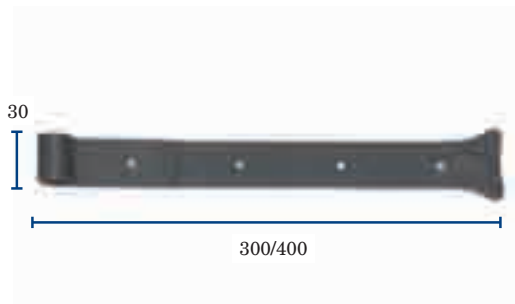

FE09240

Page 107



FE09242

Page 107



FE09244

Page 107

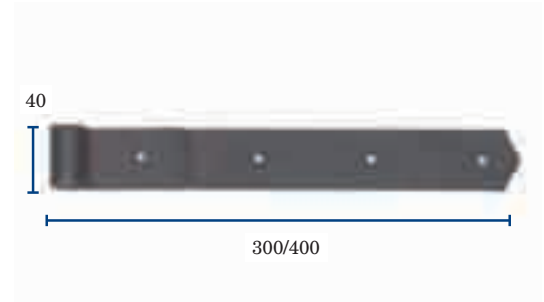

FE09246

Page 107

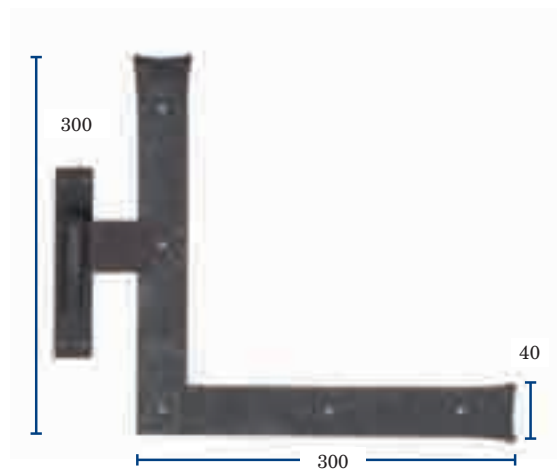
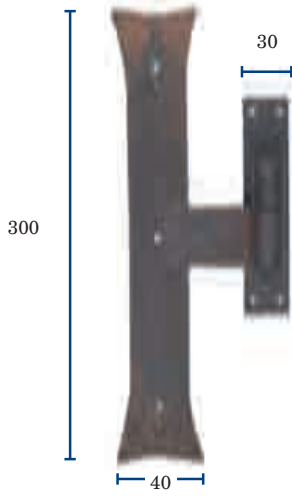

FE09215

Page 107

FE09250R

Page 108

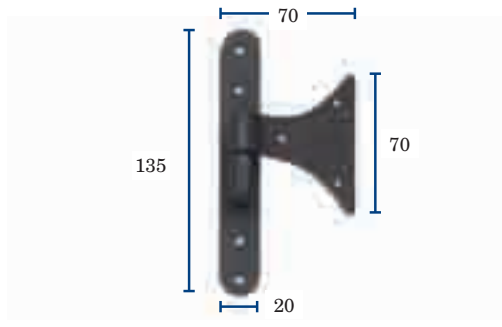
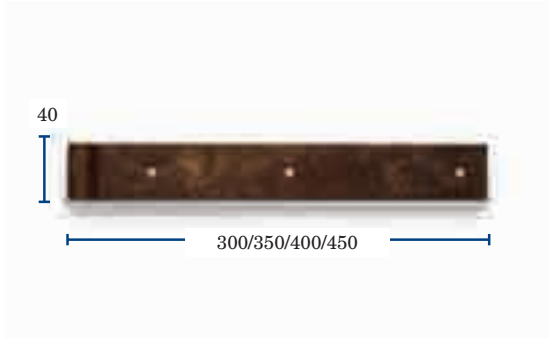

FE09260

Page 108

FE09703

Page 108

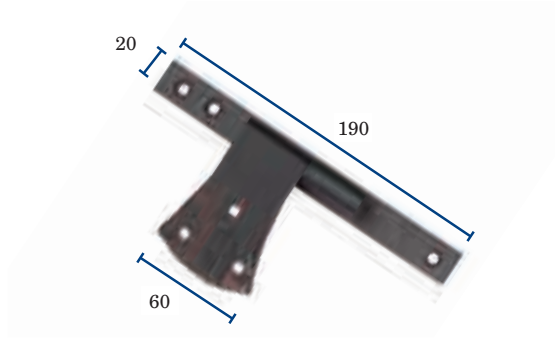
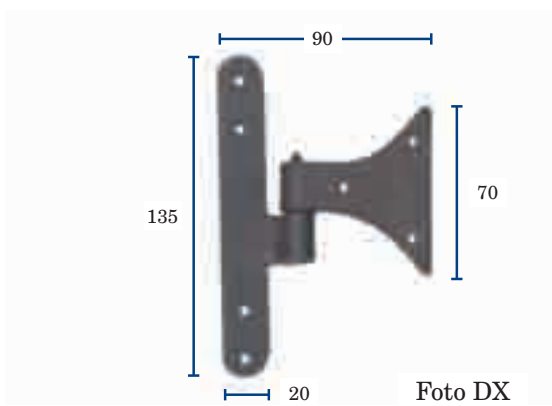



FE09704R

Page 108

FE09705

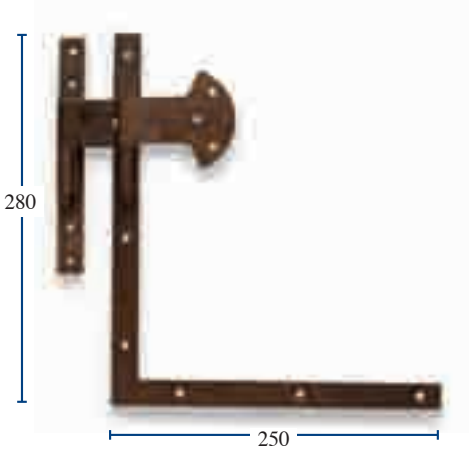
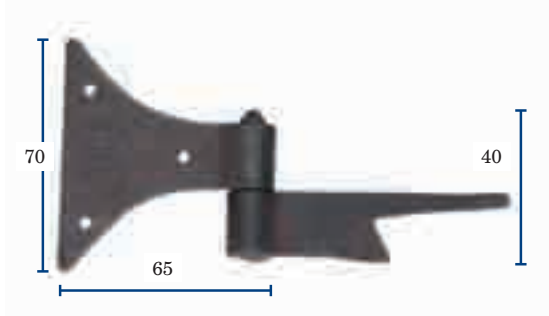
Page 108

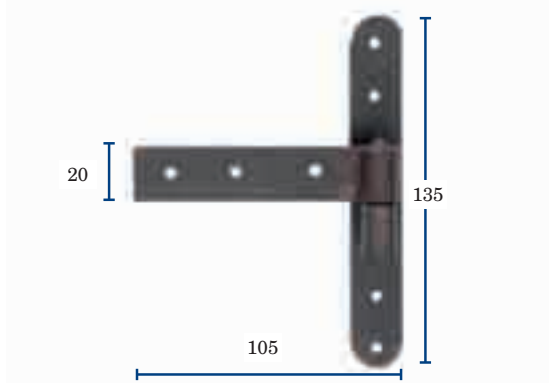
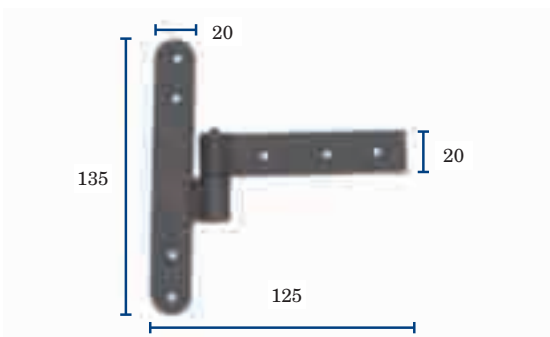
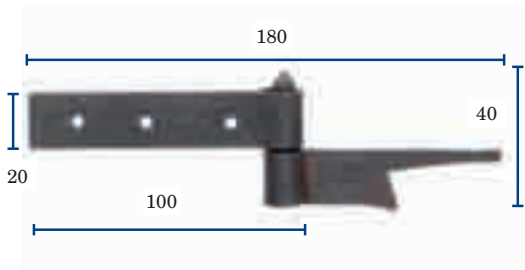
				
<p>FE09708R</p>	<p>Page 108</p>	<p>FE09709</p>	<p>Page 109</p>	
				
<p>FE09709A</p>	<p>Page 109</p>	<p>FE09710</p>	<p>Page 109</p>	
				
<p>FE09711R</p>	<p>Page 109</p>	<p>FE09712</p>	<p>Page 109</p>	

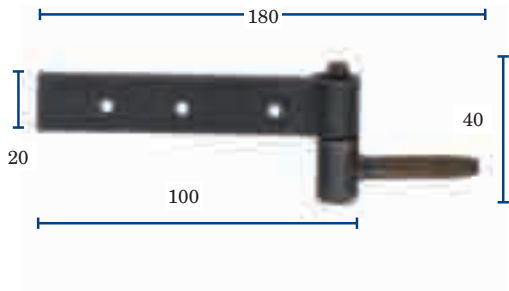

FE09712A

Page 109

FE09715R

Page 109

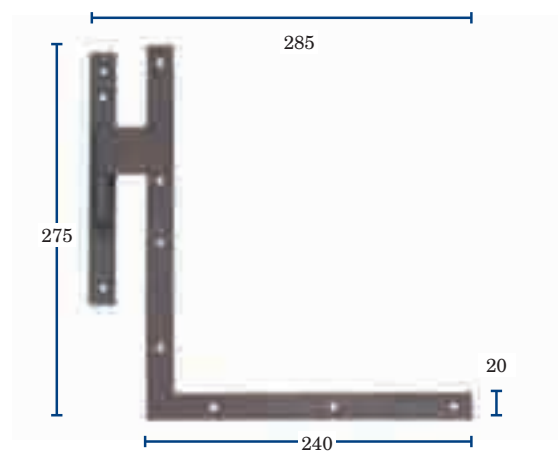
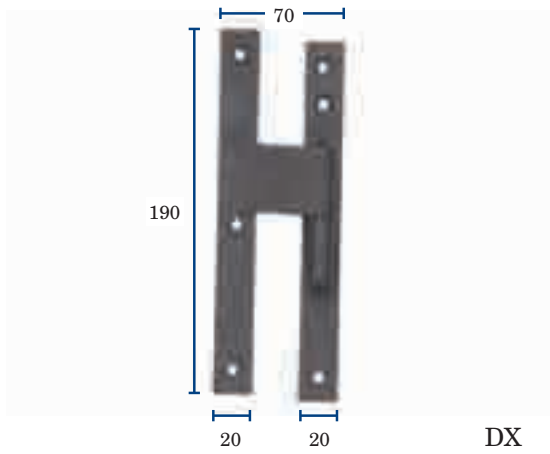

FE09718R

Page 109

FE09720R

Page 110

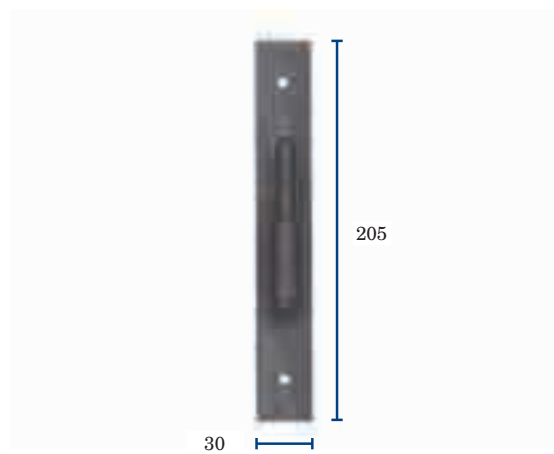

FE42201

Page 110

FE42902

Page 110

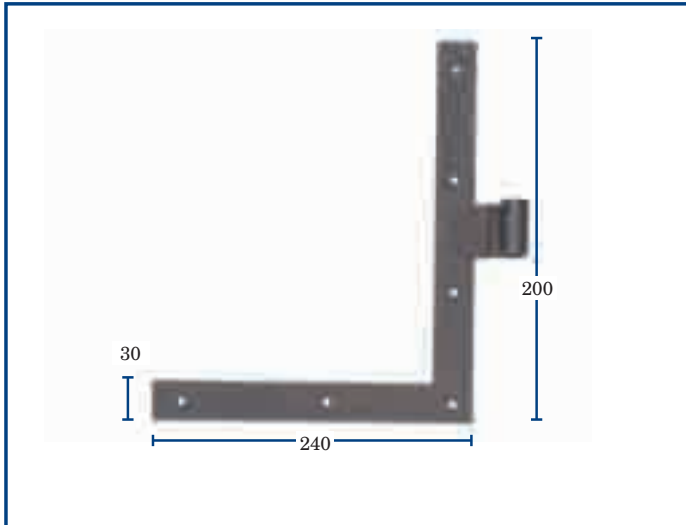

FE40502R

Page 110

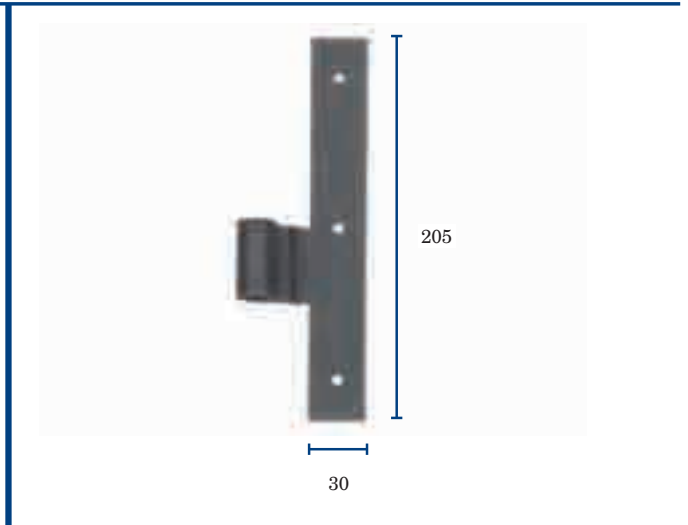

FE40903R

Page 110

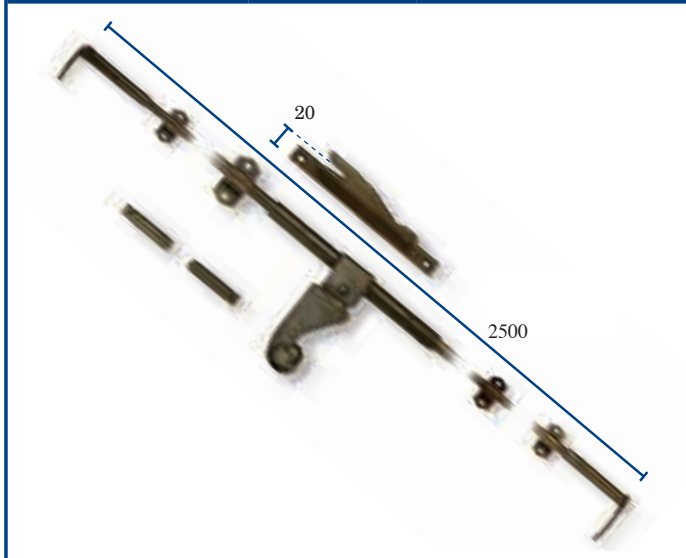

50008.C190D.27

Page 111

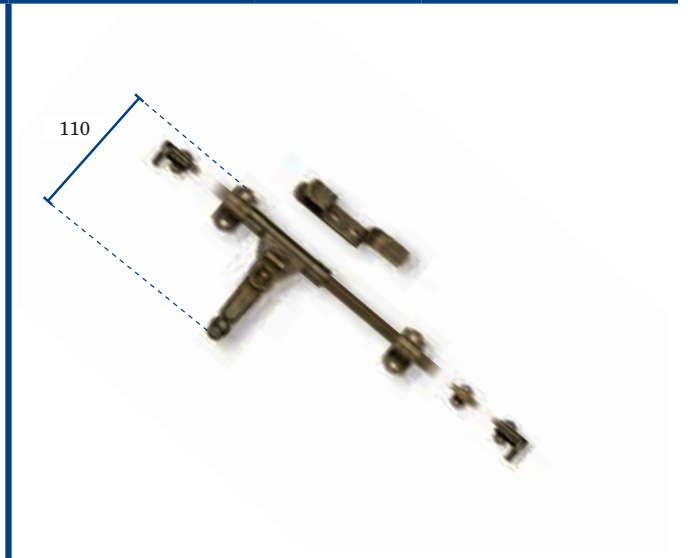

50029.11000.27

Page 111

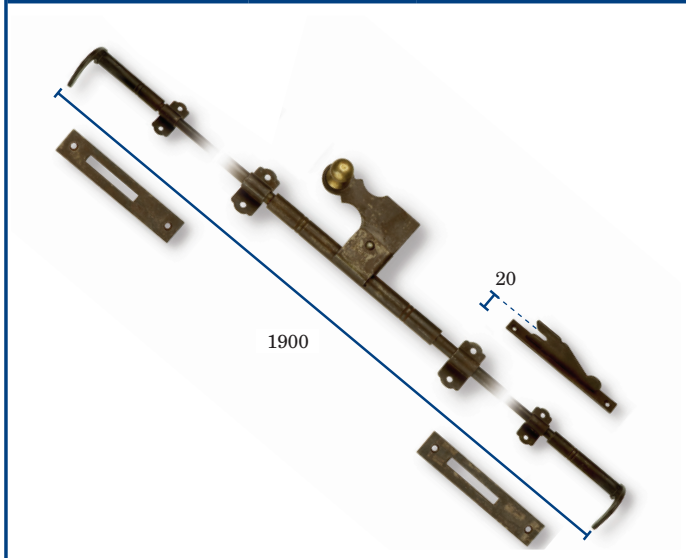

50033.C190D.27







Page 112



Handles



Frame Handles

Photo	Code	Finish description	Mat.	Measures mm		Description	Box Pcs
				Size	Ø / C to C		
Frame Handles							
	FE09001	Old iron	Iron	120x50 Q8		Handle with plate hole patent	CP 1
	FE09002	Old iron	Iron	120x50 Q8		Handle with plate hole yale	CP 1
	FE09003	Old iron	Iron	40X250X120 Q8	E90	Handle with plate hole patent	CP 1
	FE09003E70	Old iron	Iron	40X250X120 Q8	E70	Handle with plate hole patent	CP 1
	FE09014	Old iron	Iron	40X250X120 Q8	E85	Handle with plate hole yale	CP 1
	FE09018	Old iron	Iron	35X72X120 Q7		DK handle	1
	FE09006	Old iron	Iron	35X70X100 Q7		Window handle with plate	1
	FE09029	Old iron	Iron	33X140X100 Q7		Window handle with plate	1

Photo	Code	Finish description	Mat.	Measures mm		Description	Box Pcs
				Size	Ø / C to C		
	FE09052	Old iron	Iron	33X140X100		Cremorne bolts with MP movement accessories without poles	1
	FE091501	Old iron	Iron	1600		External pole half round for external cremorne	1
	FE09019	Old iron	Iron	125x45 Q8		Handle with plate hole patent	CP 1
	FE09020	Old iron	Iron	45X130 Q8		Handle with plate hole yale	CP 1
	FE09076	Old iron	Iron	40X240X130 Q8	E90	Handle with plate hole patent	CP 1
	FE09076E70	Old iron	Iron	40X240X130 Q8	E70	Handle with plate hole patent	CP 1
	FE09077	Old iron	Iron	40X240X130 Q8	E 85	Handle with plate hole yale	CP 1
	FE09027	Old iron	Iron	35X72X130 Q7		DK Handle	1

Frame Handles

Photo	Code	Finish description	Mat.	Measures mm		Description	Box Pcs
				Size	Ø / C to C		
	FE09032	Old iron	Iron	33X140X80 Q7		Window handle with plate	1
	FE09045	Old iron	Iron	35X70X80 Q7		Window handle with plate	1
	FE09025	Old iron	Iron	50X130 Q8		Handle with plate hole patent	CP 1
	FE09026	Old iron	Iron	50X130 Q8		Handle with plate hole yale	CP 1
	FE09024	Old iron	Iron	40X260X130 Q8	E90	Handle with plate hole patent	CP 1
	FE09024E70	Old iron	Iron	40X260X130 Q8	E70	Handle with plate hole patent	CP 1
	FE09078	Old iron	Iron	40X260X130 Q8	E85	Handle with plate hole yale	CP 1
	FE09035	Old iron	Iron	33X140X80 Q7		Window handle with plate	1

Photo	Code	Finish description	Mat.	Measures mm		Description	Box Pcs
				Size	Ø / C to C		
	FE09028	Old iron	Iron	35X70X80 Q7		Window handle with plate	1
	FE09053	Old iron	Iron	30X65X120 Q8		Handle with plate - hole yale and window handle	CP 1
	FE09046	Old iron	Iron	30X65X120 Q8		Handle with plate hole patent	CP 1
	FE09047	Old iron	Iron	30X65X120 Q8		Handle with plate hole yale	CP 1
	FE09060	Old iron	Iron	50X120 Q8		Handle with plate hole patent	CP 1
	FE09061	Old iron	Iron	50X120 Q8		Handle with plate hole yale	CP 1
	FE09073	Old iron	Iron	32X65X120 Q8		DK Handle	1
	FE09071	Old iron	Iron	33X40 Q7		Window handle with plate	1

Frame Handles

Photo	Code	Finish description	Mat.	Measures mm		Description	Box Pcs
				Size	Ø / C to C		
	FE09068	Old iron	Iron	70X35 Q7		Window handle with plate	1
	FE09085	Old iron	Iron	130X70 Q8		Handle with plate hole patent	CP 1
	FE09086	Old iron	Iron	130X70 Q8		Handle with plate hole yale	CP 1
	FE09087	Old iron	Iron	40X240X125 Q8	E90	Handle with plate hole patent	CP 1
	FE09087E70	Old iron	Iron	40X240X125 Q8	E70	Handle with plate hole patent	CP 1
	FE09088	Old iron	Iron	40X240X125 Q8	E85	Handle with plate hole yale	1
	FE09093	Old iron	Iron	35X72X135 Q8		DK Handle	1
	FE09092	Old iron	Iron	33X140 Q7		Window handle with plate	1

Photo	Code	Finish description	Mat.	Measures mm		Description	Box Pcs
				Size	Ø / C to C		
	FE09089	Old iron	Iron	35X70 Q7		Window handle with plate	1
	FE091015	Old iron	Iron	32X140 Q10		Pull for lift and slide	1
	FE09058	Old iron	Iron	48X70X80x30		Oval fixed knob	1
	FE09509	Old iron	Iron	48X70X80x30 Q8		Oval revolving knob	1
	FE09511	Old iron	Iron	Q8	70	Revolving knob	1
	FE09512	Old iron	Iron	Q8	55	Revolving knob	1
	26001.24000.03	Antique brass	Brass	140x240		Knocker	2
	26027.19000.03	Antique brass	Brass	109x190		Knocker	2
	26027.19000.07	Oro valenza	Brass	109x190		Knocker	2

Frame Handles









Photo	Code	Finish description	Mat.	Measures mm		Description	Box Pcs
				Size	Ø / C to C		
	26013.15500.03	Antique brass	Brass	110x155		Knocker	1
	26014.15500.03	Antique brass	Brass	112x155		Knocker	1
	26015.09000.03	Antique brass	Brass	68x90	d. 90	Knob	1
	26016.09000.03	Antique brass	Brass	68x90	d. 90	Knob	1
	26031.06400.03	Antique brass	Brass	31x90	64	Pull	6
	26031.09600.03	Antique brass	Brass	31x120	96	Pull	4
	26031.12800.03	Antique brass	Brass	41x160	128	Pull	4
	26031.16000.03	Antique brass	Brass	51x205	160	Pull	2
	26032.13200.03	Antique brass	Brass	51x200	132	Pull	2
	26032.16500.03	Antique brass	Brass	53x250	165	Pull	2
	26032.20000.03	Antique brass	Brass	55x300	200	Pull	2
	26042.25000.03	Antique brass	Brass	250x50	165	Fold pull	2

Photo	Code	Finish description	Mat.	Measures mm		Description	Box Pcs
				Size	Ø / C to C		
	FE09012	Old iron	Iron	16x250		Pull	1
	FE09013	Old iron	Iron	16x200		Pull	1
	FE09039	Old iron	Iron	275X50		Pull	1
	FE09040	Old iron	Iron	270X73		Pull	1
	FE09041	Old iron	Iron	345X90		Pull	1
	FE09054	Old iron	Iron	310x60		Inclined pull	1
	FE09055	Old iron	Iron	230x60		Inclined pull	1
	FE09080	Old iron	Iron	245X80	180	Fold pull - not centered	1
	FE09081	Old iron	Iron	230x45		Pull	1

Frame Handles

Photo	Code	Finish description	Mat.	Measures mm		Description	Box Pcs
				Size	Ø / C to C		
	FE09501	Old iron	Iron	140x180		Knocker	1
	FE09503	Old iron	Iron	110x190		Knocker	1
	FE09504	Old iron	Iron	120x155		Knocker	1
	FE09505	Old iron	Iron	115x150		Knocker	1
	FE09507	Old iron	Iron	120x160		Knocker	1

Photo	Code	Finish description	Mat.	Measures mm		Description	Box Pcs
				Size	Ø / C to C		
	FE09510	Old iron	Iron	50x200		Knocker	1
	FE09513	Old iron	Iron	160x210		Knocker	1
	FE09502	Old iron	Iron		d.70	Fixed knob	1
	FE09506	Old iron	Iron		d.55	Fixed knob	1
	FE09048	Old iron	Iron	190	d.10	Pull	1
	FE09049	Old iron	Iron	125	d.8	Pull	1
	FE09056	Old iron	Iron	75x75		Handle	1
	FE09074	Old iron	Iron	Q6	d. 57	Ratchet wc for sliding door Kit free-occupied with hole d.48	1
	FE09075	Old iron	Iron		d. 57	KIT pull handle without hole hole d.48	1
	FE09075FC	Old iron	Iron		d. 57	Kit free-occupied with hole patent hole d.48	1

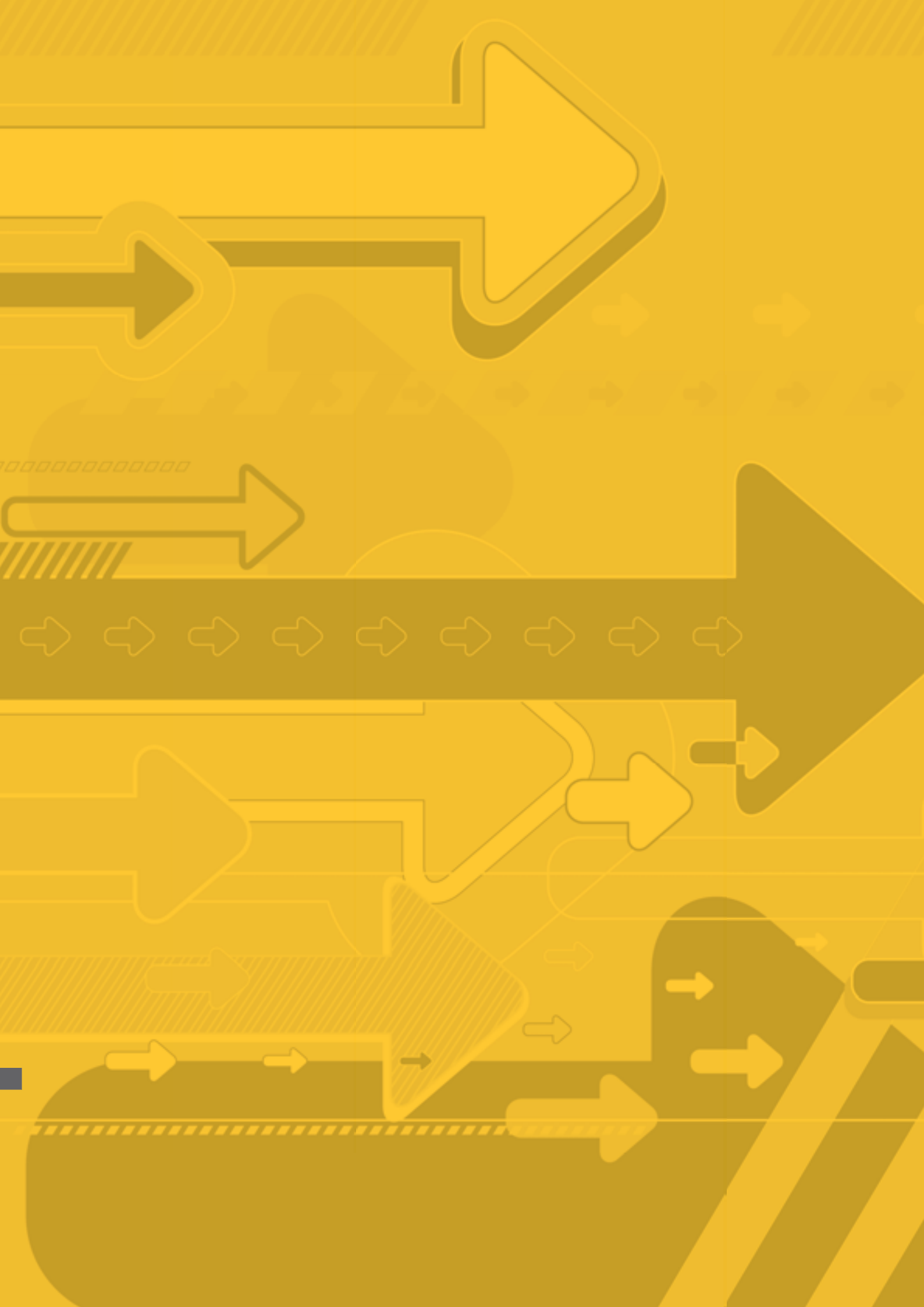



Restoration products



Trimming

Restoration

Photo	Code	Finish description	Measures mm		Description	Box Pcs
			Size	Ø / C to C		
	AT111	Natural color	lt. 0,5		Larvicidal anti-woodworm Timpest	1
	AT112	Natural color	lt. 1		Larvicidal anti-woodworm Timpest	1
	AT113	Natural color	lt. 2,5		Larvicidal anti-woodworm Timpest	1
	AT114	Natural color	lt. 10		Larvicidal anti-woodworm Timpest	1
	AT300	Natural color	lt. 1		Water-based anti-woodworm Timpest	1
	59006.50000.00C	Natural color	lt. 0,5		Anti-woodworm Timpest	1
	59006.C1000.00C	Natural color	lt. 1		Anti-woodworm Timpest	1
	59006.C2500.00	Natural color	lt.2,5		Anti-woodworm Timpest	1
	59006.D1000.00	Natural color	lt.10		Anti-woodworm Timpest	1
	59007.C1000.00	Natural color	lt.1		Anti-woodworm odorless	6
	59007.C5000.00	Natural color	lt. 5		Anti-woodworm odorless	4
	59018.C5000.00	Natural color	kg.5		Slipperwax	1
	59036.C1000.00C	Natural color	kg.1		Bologna chalk	1
	59037.D5000.00	Natural color	kg. 50		Shellac	1
	59037.D2500.00C	Natural color	kg. 25		Shellac	1
	59037.C1000.00	Natural color	kg. 1		Shellac	1
	59136.C1000.00C	Natural color	kg. 1		Dewaxed shellac	1







Photo	Code	Finish description	Measures mm		Description	Box Pcs
			Size	Ø / C to C		
	59044.C1000.00	Natural color	lt.1		Straw yellow oil	1
	59044.C5000.00	Natural color	lt.5		Straw yellow oil	1
	59085.C1000.00C	Natural color	lt.1		Straw red oil	1
	59087.C1000.00C	Natural color	lt.1		Consolidating agent for wood	1
	59089.00000.G2	Light walnut			Colour edging pen	12
	59089.00000.L4	Medium walnut			Colour edging pen	12
	59089.00000.G3	Dark walnut			Colour edging pen	12
	59089.00000.G4	Wenghè			Colour edging pen	12
	59089.00000.G5	Reddish brown			Colour edging pen	12
	59091.00000.H1C	Gold			Colour edging pen	12
	59091.00000.E1C	Silver			Colour edging pen	12
	59091.00000.F1C	White			Colour edging pen	12
	59091.00000.P1C	Black			Colour edging pen	12
	59092.C1000.00	Natural color	kg.1		Pumice	6
	59098.75000.L1	National walnut	gr. 750		Two-components filler	1
	59098.75000.L2	Light walnut	gr. 750		Two-component filler	1
	59098.75000.L3	Dark walnut	gr. 750		Two-components filler	1
	59098.12500.L1C	National walnut	gr. 125		Two-components filler	1
	59098.12500.L2C	Light walnut	gr. 125		Two-component filler	1
	59098.12500.L3C	Dark walnut	gr. 125		Two-components filler	1

Photo	Code	Finish description	Measures mm		Description	Box Pcs
			Size	Ø / C to C		
	59099.C1000.00C	Natural color	ml.750		Resin	1
	59099.C5000.00C	Natural color	kg.5		Resin	1
	59099.D1000.00C	Natural color	kg.10		Resin	1
	59102.C1000.L2C	Light walnut	kg.1		Waterborne filler	1
	59102.C1000.L3C	Dark walnut	kg.1		Waterborne filler	1
	59102.C1000.L4C	Medium walnut	kg.1		Waterborne filler	1
	59102.C5000.L2C	Light walnut	kg.5		Waterborne filler	1
	59102.C5000.L3C	Dark walnut	kg.5		Waterborne filler	1
	59102.C5000.L4C	Medium walnut	kg.5		Waterborne filler	1
	59102.C5000.02C	Durmast	kg.5		Waterborne filler	1
	59102.C5000.06C	Fir	kg.5		Waterborne filler	1
	59102.50000.M1C	Mahogany	gr.500		Waterborne filler	1
	59102.50000.01C	Cherry	gr.500		Waterborne filler	1
	59102.50000.02C	Durmast	gr.500		Waterborne filler	1
	59102.50000.06C	Fir	gr.500		Waterborne filler	1
	59102.50000.P1C	Black	gr.500		Waterborne filler	1
	59121.00800.A2C	Orange	gr.8		Alcool-based aniline	10
	59121.00800.D1C	Blue	gr.8		Alcool-based aniline	10
	59121.00800.01C	Cherry	gr.8		Alcool-based aniline	10
	59121.00800.A1C	Yellow	gr.8		Alcool-based aniline	10
	59121.00800.P2C	Grey	gr.8		Alcool-based aniline	10
	59121.00800.M1C	Mahogany	gr.8		Alcool-based aniline	10
	59121.00800.P1C	Black	gr.8		Alcool-based aniline	10
	59121.00800.L5C	Antique walnut	gr.8		Alcool-based aniline	10
	59121.00800.L2C	Light walnut	gr.8		Alcool-based aniline	10
	59121.00800.L4C	Medium walnut	gr.8		Alcool-based aniline	10
	59121.00800.07C	Rosewood	gr.8		Alcool-based aniline	10
	59121.00800.Q1C	Red	gr.8		Alcool-based aniline	10
	59121.00800.08C	Teak	gr.8		Alcool-based aniline	10
	59121.00800.I1C	Green	gr.8		Alcool-based aniline	10

Photo	Code	Finish description	Measures mm		Description	Box Pcs
			Size	Ø / C to C		
	59122.00800.A2C	Orange	gr.8		Water-based aniline	10
	59122.00800.D2C	Light blue	gr.8		Water-based aniline	10
	59122.00800.01C	Cherry	gr.8		Water-based aniline	10
	59122.00800.A1C	Yellow	gr.8		Water-based aniline	10
	59122.00800.P2C	Grey	gr.8		Water-based aniline	10
	59122.00800.M1C	Mahogany	gr.8		Water-based aniline	10
	59122.00800.P1C	Black	gr.8		Water-based aniline	10
	59122.00800.L5C	Antique walnut	gr.8		Water-based aniline	10
	59122.00800.L2C	Light walnut	gr.8		Water-based aniline	10
	59122.00800.L4C	Medium walnut	gr.8		Water-based aniline	10
	59122.00800.07C	Rosewood	gr.8		Water-based aniline	10
	59122.00800.Q1C	Red	gr.8		Water-based aniline	10
	59122.00800.08C	Teak	gr.8		Water-based aniline	10
	59122.00800.I1C	Green	gr.8		Water-based aniline	10
		59124.60000.00	Natural color	300x600mm		Polishing gauze -pc.50
	59125.39000.00C	Natural color	380x390mm		Cloth with wax - Pc.48	1
	59127.C1000.00	Natural color	kg.1		White cotton	1
	59131.C1000.00C	Natural color	lt.1		Antique patina	1

Photo	Code	Finish description	Measures mm		Description	Box Pcs
			Size	Ø / C to C		
	SVE2011750M		ml.750		Paint stripper - ecologic	1
	SVE201104L		lt. 4		Paint stripper - ecologic	1
	SVE2011020L		lt. 20		Paint stripper - ecologic	1
	61004.02000.00C	Natural color	gr.20		Instant adhesive	1
	61004.50000.00C	Natural color	gr.500		Instant adhesive	1
	61010.50000.00	Trasparente	gr.500		Glue for trimmings	1
	61013.C5000.00C	Natural color	vinacoll 406 kg.5		Vinyl glue for wallpaper	1
	61013.D1000.00C	Natural color	vinacoll 406 kg.10		Vinyl glue for wallpaper	1
	61014.C5000.00C	Natural color	legnodur 101 kg.5		Rapid vinyl glue for wood	1
	61014.D1000.00C	Natural color	legnodur 101 kg.10		Rapid vinyl glue for wood	1
	61015.C5000.00C	Natural color	legnodur 4701 kg.5		Vinyl glue for wood	1
	61015.D1000.00C	Natural color	legnodur 4701 kg.10		Vinyl glue for wood	1
	61019.C1000.00	Natural color	kg.1		Bone glue in pearl form	10
	61019.D2500.00	Natural color	Kg.25		Bone glue in pearl form	1









Photo	Code	Finish description	Measures mm		Description	Box Pcs
			Size	Ø / C to C		
	61021.01000.00C	Natural color	Kg.1		Rabbit skin glue	1
	61022.C7500.00C	Natural color	mt. 7,5		Strap	1
	61022.D5000.00C	Natural color	mt. 50		Strap	1
	61023.C1000.00C	Natural color	lt.1		Turpentine	1
	61023.C5000.00C	Natural color	lt.5		Turpentine	1
	61024.C1000.00C	Natural color	lt.1		Diluent	1
	61024.C5000.00C	Natural color	lt.5		Diluent	1
	61032.20000.00C	Natural color	gr.200		Hardener for mixer and resin	1
	61033.C1000.00C	Natural color	kg.1		Caustic soda	1
	61034.C1000.00C	Natural color	lt.1		Turpentine	1
	62011.00100.00	Natural color	gr.100		Steel wool "0000"	12

Photo	Code	Finish description	Measures mm		Description	Box Pcs
			Size	Ø / C to C		
	62011.01000.00	Natural color	kg.1		Steel wool "0000"	6
	62011.06000.00	Natural color	kg.6		Steel wool "0000"	2
	62019.06000.00	Natural color	kg.6		Steel wool "00000"	2
	62010.D1000.00	Natural color	kg.10		National Steel wool big	1
	69033.05000.21	rough iron	50x100		Stick to get ancient look	1
	69033.03500.21C	rough iron	35x90		Stick to get ancient look	1
	69084.50000.00	Natural color	gr. 500		Hammer for veenering	1
	69102.00000.00	Natural color			Brush for furniture	1
	69110.00500.00	Natural color			Brush with brass wires for furniture	1
	69134.00000.21	rough iron			Glue pan	1
	73007.05000.57	Brown	h. 66mm x mt.50		Tape pvc havana	12

Photo	Code	Finish description	Measures mm		Description	Box Pcs
			Size	Ø / C to C		
	73025.01900.00C	Natural color	h. 19mm x mt.50		Paper tape	12
	73026.02500.00C	Natural color	h. 25mm x mt.50		Paper tape	12
	73027.03000.00C	Natural color	h. 30mm x mt.50		Paper tape	12
	73028.03800.00C	Natural color	h. 38mm x mt.50		Paper tape	12
	73029.05000.00C	Natural color	h. 50mm x mt.50		Paper tape	6
	61016.01000.00C	Transparent	kg.1		Glue sticks for hot gun	1
	6-GR25	Natural color			Hot glue gun	1
	FA310601	Blonde	lt.1		Shellac	1
	FA310605	Blonde	lt.5		Shellac	1
	FA311501	Transparent	lt.1		Shellac	1
	FA311505	Transparent	lt.5		Shellac	1
	FA421675	Natural color	gr.750		Mordant - walnut	1
	B4101	Neutral	ml.500		Beeswax in past form (bees and carnauba wax) HOLZ-WACHS	1
	B4153	Light walnut	ml.500		Beeswax in past form (bees and carnauba wax) HOLZ-WACHS	1
	B4163	Medium walnut	ml.500		Beeswax in past form (bees and carnauba wax) HOLZ-WACHS	1
	B4167	Dark walnut	ml.500		Beeswax in past form (bees and carnauba wax) HOLZ-WACHS	1
	B4190	Yellow	ml.500		Beeswax in past form (bees and carnauba wax) HOLZ-WACHS	1
	B4301	Neutral	lt.5		Beeswax in past form (bees and carnauba wax) HOLZ-WACHS	1
	B4353	Light walnut	lt.5		Beeswax in past form (bees and carnauba wax) HOLZ-WACHS	1
	B4363	Medium walnut	lt.5		Beeswax in past form (bees and carnauba wax) HOLZ-WACHS	1
	B4367	Dark walnut	lt.5		Beeswax in past form (bees and carnauba wax) HOLZ-WACHS	1

Photo	Code	Finish description	Measures mm		Description	Box Pcs
			Size	Ø / C to C		
	B9002	Silver	14x14		Imitation leaf - 25 sheet	1
	B9005	Bronze	14x14		Imitation leaf - 25 sheet	1
	B9012	Gold	14x14		Imitation leaf - 25 sheet	1
	B9032	Gold	10mmx50mt		Imitation roll	1
	B9033	Gold	25mmx50mt		Imitation roll	1
	B9100	Natural color	ml. 150		Water Goldsize	1
	B9103	Natural color	ml. 250		Oil Goldsize	1
	B9110	Yellow	gr. 250		Bole	1
	B9111	Red	gr. 250		Bole	1
	B9112	Black	gr. 250		Bole	1
	B9201	Natural color			Leather gilder cushion	1
	B9203	Natural color			Double edge knife	1
	B9227	Natural color	50mm		Gilder's tip - pure squirrel	1
	B9229	Natural color	75mm		Gilder's tip - pure squirrel	1

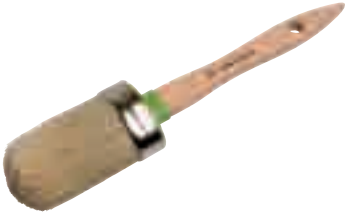



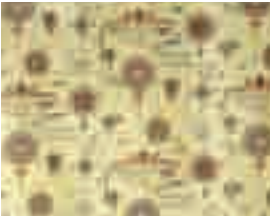

Photo	Code	Finish description	Measures mm		Description	Box Pcs
			Size	Ø / C to C		
	NON9343004	Natural color	Bristle 4		"Ovalino" brush	1
	NON9343006	Natural color	Bristle 6		"Ovalino" brush	1
	NON9343008	Natural color	Bristle 8		"Ovalino" brush	1
	NON9343010	Natural color	Bristle 10		"Ovalino" brush	1
	NON9343012	Natural color	Bristle 12		"Ovalino" brush	1
	NON9343014	Natural color	Bristle 14		"Ovalino" brush	1
	NON9343016	Natural color	Bristle 16		"Ovalino" brush	1
	NON9116120	Natural color	Bristle 20		Flat brush	1
	NON9116130	Natural color	Bristle 30		Flat brush	1
	NON9116140	Natural color	Bristle 40		Flat brush	1
	NON9116150	Natural color	Bristle 50		Flat brush	1
	NON9116160	Natural color	Bristle 60		Flat brush	1
	B4501	Neutral	lt.5		Liquid wax	1
	56008.50000.00	Natural color		700x500	Varese paper	250
	56011.C1000.00	Natural color		700x1000	Varese paper	250
	56014.C1000.00	Bordeaux		700x1000	Varese paper	250

Photo	Code	Finish description	Measures mm		Description	Box Pcs
			Size	Ø / C to C		
	56015.C1000.00	Natural color		700x1000	Varese paper	250
	56032.50000.00	Brown		700x500	Varese paper	250
	56032.C1000.00	Brown		700x1000	Varese paper	250
	56033.50000.00	Red		700x500	Varese paper	250
	56033.C1000.00	Red		700x1000	Varese paper	250
	56034.50000.00	Green		700x500	Varese paper	250
	56034.C1000.00	Green		700x1000	Varese paper	250
	56035.50000.00	Blue		700x500	Varese paper	250
	56035.C1000.00	Blue		700x1000	Varese paper	250
	56037.50000.00	Brown		700x500	Varese paper	250
	56037.C1000.00	Brown		700x1000	Varese paper	250
	56039.50000.00	Green		700x500	Varese paper	250
	56039.C1000.00	Green		700x1000	Varese paper	250
	56062.C1000.00	Brown		700x1000	Varese paper	250

Photo	Code	Finish description	Measures mm		Description	Box Pcs
			Size	Ø / C to C		
	56050.00000.A1	Yellow			Tripolino tassel	50
	56050.00000.B1	Beige			Tripolino tassel	50
	56050.00000.D2	Light blue			Tripolino tassel	50
	56050.00000.F1	White			Tripolino tassel	50
	56050.00000.I1	Green			Tripolino tassel	50
	56050.00000.Q2	Pink			Tripolino tassel	50
	56050.00000.Q3	Bordeaux			Tripolino tassel	50
	56051.00000.A1	Yellow			Tripolino tassel	50
	56051.00000.B1	Beige			Tripolino tassel	50
	56051.00000.D2	Light blue			Tripolino tassel	50
	56051.00000.F1	White			Tripolino tassel	50
	56051.00000.I1	Green			Tripolino tassel	50
	56051.00000.Q2	Pink			Tripolino tassel	50
	56051.00000.Q3	Bordeaux			Tripolino tassel	50
	56059.D2500.A1C	Yellow	d. 6	mt. 25	Cord	1
	56059.D2500.B1C	Beige	d. 6	mt. 25	Cord	1
	56059.D2500.F1C	White	d. 6	mt. 25	Cord	1
	56059.D2500.G1C	Brown	d. 6	mt. 25	Cord	1
	56060.D2500.A1C	Yellow	d.8	mt. 25	Cord	1
	56060.D2500.B1C	Beige	d.8	mt. 25	Cord	1
	56060.D2500.E1C	Silver	d.8	mt. 25	Cord	1
	56060.D2500.F1C	White	d.8	mt. 25	Cord	1
	56060.D2500.G1C	Brown	d.8	mt. 25	Cord	1
	56060.D2500.H1C	Gold	d.8	mt. 25	Cord	1
	56060.D2500.P1C	Black	d.8	mt. 25	Cord	1
	56061.D2500.A1C	Yellow	d. 10	mt. 25	Cord	1
	56061.D2500.B1C	Beige	d. 10	mt. 25	Cord	1
	56061.D2500.F1C	White	d. 10	mt. 25	Cord	1
	56061.D2500.G1C	Brown	d. 10	mt. 25	Cord	1

Photo	Code	Finish description	Measures mm		Description	Box Pcs
			Size	Ø / C to C		
	56059.M2500.A1	Yellow	d. 6	mt. 250	Cord	1
	56059.M2500.B1	Beige	d. 6	mt. 250	Cord	1
	56059.M2500.F1	White	d. 6	mt. 250	Cord	1
	56059.M2500.G1	Brown	d. 6	mt. 250	Cord	1
	56060.M3000.A1	Yellow	d. 8	mt. 300	Cord	1
	56060.M3000.B1	Beige	d. 8	mt. 300	Cord	1
	56060.M3000.F1	White	d. 8	mt. 300	Cord	1
	56060.M3000.G1	Brown	d. 8	mt. 300	Cord	1
	56061.M2000.A1	Yellow	d. 10	mt. 200	Cord	1
	56061.M2000.B1	Beige	d. 10	mt. 200	Cord	1
	56061.M2000.F1	White	d. 10	mt. 200	Cord	1
	56061.M2000.G1	Brown	d. 10	mt. 200	Cord	1
	56064.00000.00	Yellow/Light Brown			Estrella tassel	50
	56064.00000.A1	Yellow			Estrella tassel	50
	56064.00000.B1	Beige			Estrella tassel	50
	56064.00000.D2	Light blue			Estrella tassel	50
	56064.00000.I1	Green			Estrella tassel	50
	56064.00000.Q2	Pink			Estrella tassel	50
	56065.00000.00	Multicolour			Estrella tassel-multicolour	50
	56066.00000.00	Multicolour			Estrella tassel-multicolour	50

Photo	Code	Finish description	Measures mm		Description	Box Pcs
			Size	Ø / C to C		
	65071.C1000.03	Antique brass		11,3x1000	Iron tack	125
	65108.C1000.03C	Antique brass		9x1000	Iron tack	250
	65072.00900.03	Antique brass		9,5	Iron tack Pc. Box 1000	1
	65072.01100.03	Antique brass		11	Iron tack Pc. Box 1000	1
	65073.01000.13	Bronzed		10,5	Iron tack Pc. Box 1000	1
	65074.01300.03	Antique brass		13	Iron tack Pc. Box 1000	1
	65075.01400.03	Antique brass		14	Iron tack Pc. Box 1000	1
	65076.01000.03	Antique brass		10,5	Iron tack Pc. Box 1000	1
	65088.01800.03	Antique brass		18x18	Iron tack Pc. Box 1000	1
	73037.C2000.00C	Various		2000x1500	Blanket	10

